



The heart of kart

X30
BY IAME

125cc RL - TaG



ASSEMBLY INSTRUCTIONS
&
USER MANUAL



I N D E X

PAGE

Section 1	<u>DESCRIPTION OF THE "Parilla X30 125cc RL - TaG" ENGINE</u>	
1.1.	Main features	02
1.2.	Characteristics of the Engine / Operational limits	03
1.3.	Contents of packing	04
1.4.	Accessories	05
1.5.	Motor identification number	06
Section 2	<u>PREPARATION & INSTALLATION OF THE ENGINE ON THE CHASSIS</u>	
2.1.	Installation sketch of the engine on the chassis	07
2.2.	Install the water-cooling system	08
2.3.	Exhaust header assembly	12
2.4.	Preparation and installation of the motor-mount	12
2.5.	Install the carburettor	13
2.6.	Install the engine on the chassis	14
2.7.	Install the clutch cover with H.T. coil	15
2.8.	Mounting of the electric plant and connectors	16
2.9.	Install the intake silencer	20
2.10.	Install the exhaust	21
Section 3	<u>ENGINE USE</u>	
3.1.	Charging of the oil in the gear box	22
3.2.	Gasoline and oil	22
3.3.	Carburetor adjustment guide	23
3.4.	Starting and stopping the engine	24
3.5.	Engine running-in	25
3.6.	RPM limitation	25
3.7.	Inlet silencer	25
3.8.	Recommendations on the exhaust system	26
3.9.	Recommendations on the battery	27
3.10.	Warnings on the electrical system	28
3.11.	Spark plug and thermal degree	29
3.12.	Choice of the sprocket ratio	30
Section 4	<u>ENGINE BASIC MAINTENANCE</u>	
4.1.	Centrifugal Clutch	33
4.2.	Instructions for the clutch disassembly\ assembly	34
4.3.	Gear timing schematic	35
4.4.	Replacement of the starter brushes	36
4.5.	Scheduled maintenance	42
4.6.	Troubleshooting	43
4.7.	Engine and accessories preservation	44
4.8.	Torque Value	45
	Wiring diagram	46

Section 1 - DESCRIPTION OF THE "Parilla X30 125cc RL - TaG" ENGINE

1.1 MAIN FEATURES

The "Parilla X30" has been expressly designed and tuned for powering the karts for hobby racing on closed tracks destined for this specific purpose.

When designing this new engine, we have considered the technical solutions already adopted for the high performance engines, and the experience acquired with the TaG engines (Touch and Go). This in order to guarantee the highest reliability of components, when the operating limits are respected.

This engine is a 2 stroke single cylinder.

The cylinder and the crankcase are in aluminium alloy.

The pressed liner is made of centrifugated cast iron, fully machined to guarantee the best possible stability and sliding surface.

The head is separated from the cylinder and secured by 4 studs.

The crankshaft is built and supported by two ball-bearings. The crankshaft is of steel alloy, hardened and tempered, as the connecting rod, machined from the full, which runs on roller bearings.

The crankcase houses a balance shaft, driven by two gears, which rotates opposite to the crankshaft thus reducing the engine vibrations.

The digital ignition with capacitive discharge is fed by a magneto which generates the spark energy for the starting of the engine, supplies the advance timing through an integrated pick-up and recharges the battery.

The ignition includes a digital electronic unit, the stator-rotor, the starter relay, the H.T. coil, a switch key assembly, and the wiring harness (with a 5A fuse) which connects the whole system.

The electronic box which controls the advance, the rev. limitation and the engine start/stop logic, integrates the voltage regulator and the ignition circuit.

The starter relay (Solid type SSR), protected from short-circuits, supplies the power for the electric starter and is controlled by the power pack.

An RPM limiter, integrated in the power pack, prevents the engine from exceeding 14.000, 15.500 or 16.000 RPM during use, depending on the engine versions.

The spark is generated also without a battery; it is therefore possible, in case of emergency, to start the engine with an external starter unit.

With the starter key in "RUN" position, the starter activates the Bendix which engages the starter wheel assembled on the clutch.

The engine is provided with an automatic dry centrifugal clutch with low maintenance and with interchangeable sprocket.

The carburetor is a diaphragm carburetor, specially designed for this engine and includes an integral fuel pump filter and an all position mounting capability.

The battery (12 V - 9 Ah) is a sealed, no maintenance one and is not supplied with the engine, it has to be allocated in the support box which can be easily adapted to all existing chassis.

The exhaust, included in the supply, is already tuned for the best possible performance.

The engine is supplied with a kit which includes the radiator, the pump, water hoses and whatever necessary for the assembly on the kart.

1.2 CHARACTERISTICS OF THE ENGINE – OPERATIONAL LIMITS

The characteristics of the engine are the following :

- Cycle: OTTO / 2 stroke
- Original cubic capacity: 123.67 cc (125cc max.)
- Original bore: 54.00 mm
- Max. theoretical bore: 54.28 mm
- Stroke: 54.00 mm
- Lubrication: Fuel / oil mix 4% (25:1)
- Induction: Reed valve in the crankcase
- Carburettor: Membrane (TRYTON HOBBY 27-C – Ø26)
- Cooling: Water , forced
- Ignition: Digital/with integrated rev. limiter
- Battery charge: With integral generator
- Electric start: 12V/0.30 Kw
- Clutch: Automatic, dry, centrifugal

Operational limits:

- Max. RPM: 14.000, 15.500 and 16.000 (with rev. limiter)
(depending on the versions)
- Min. water temperature: 45°C
- Max. water temperature: 65°C



WARNING:

Never exceed the above limits; no obligation of IAME exists in case the above limits are exceeded.

1.3 CONTENTS OF THE PACKING

Each "Parilla X30" engine is supplied with the accessories under shown:

EXHAUST SYSTEM	QUANTITY
• Flexible hose	1
• Spring for flexible	3
• Exhaust sheath	1
• Exhaust manifold	1
• Exhaust muffler	1
INDUCTION	
• TRYTON HOBBY 27-C carburettor – Ø26	1
• Intake silencer	1
ELECTRICAL PLANT	
• Battery support plate	1
• Battery support	1
• Battery stripe	1
• Battery fixing clamps & dampeners	2
• Mounting screws & washers kit	1
• Electronic box	1
• Starter relay	1
• H.T. coil	1
• Starting key assembly	1
• Fixing clamps	8
• NGK BR 10 EG spark plug	1
• Spark plug cap	1
MISCELLANEOUS	
• Clutch cover	1
• Starter brushes kit (refill)	1
• Dual-Lock fixing strap	1
WATER COOLING SYSTEM	
• Radiator	1
• Radiator support kit	1
• Water hose kit	1
• Complete pump group	1
• Thermostat	1

1.4 ACCESSORIES



EXHAUST SYSTEM



SPARK PLUG KIT



BRUSHES KIT

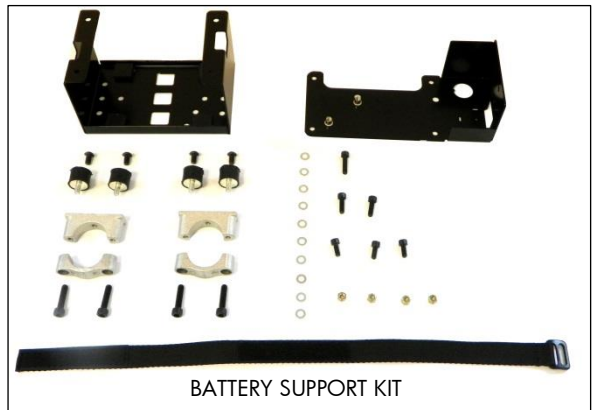

BATTERY SUPPORT KIT

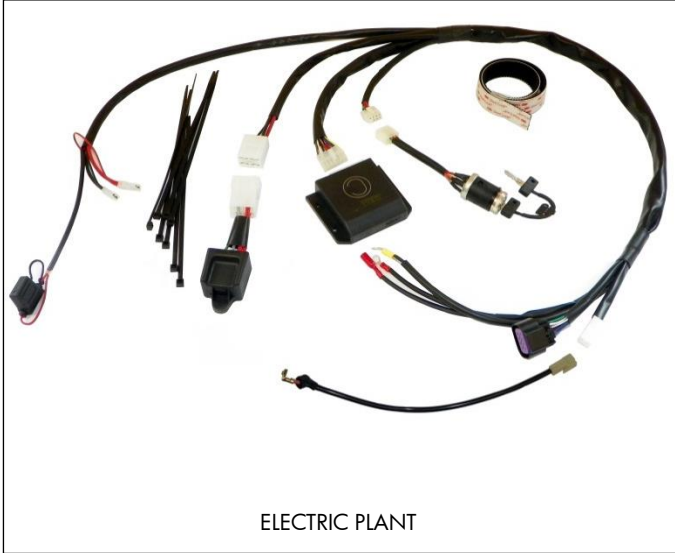

ELECTRIC PLANT



THERMOSTAT



CLUTCH COVER / H.T. COIL



CARBURETTOR TRYTON HOBBY



RADIATOR SUPPORT KIT



INLET SILENCER



WATER PUMP ASSEMBLY



WATER HOSES KIT



RADIATOR

1.5 ENGINE IDENTIFICATION NUMBER

The official motor identification number can be found stamped on the lower left part of the crankcase, next to the electric starter (see fig.). The number normally includes a letter followed by 4 digits (there can be exceptions in some special cases). Other numbers stamped on the crankcase or other surfaces of the motor refer to various manufacturing processes and do not identify the motor.

NOTE:

In case of need for spares and when contacting the IAME Support Centers, please always refer to the Motor Identification Number and to the motor model.

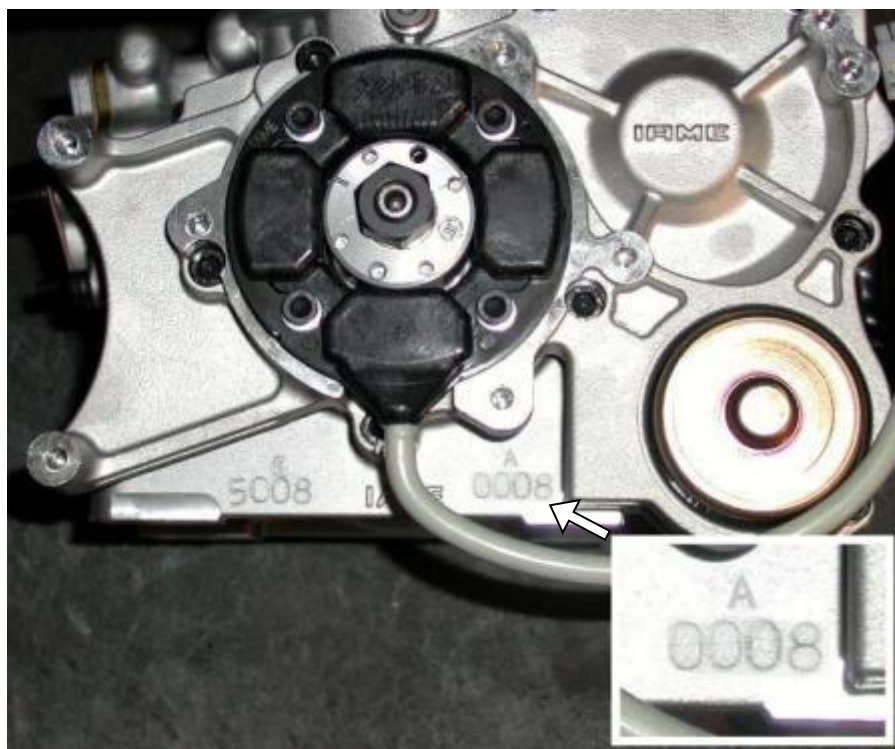

Section 2 - PREPARATION AND INSTALLATION OF THE ENGINE ON THE CHASSIS

NOTE:

In case the engine is supplied already assembled on the chassis, it is at care of the assembler to follow these instructions. The final customer, in this case, can skip this section and can start reading from section 3.

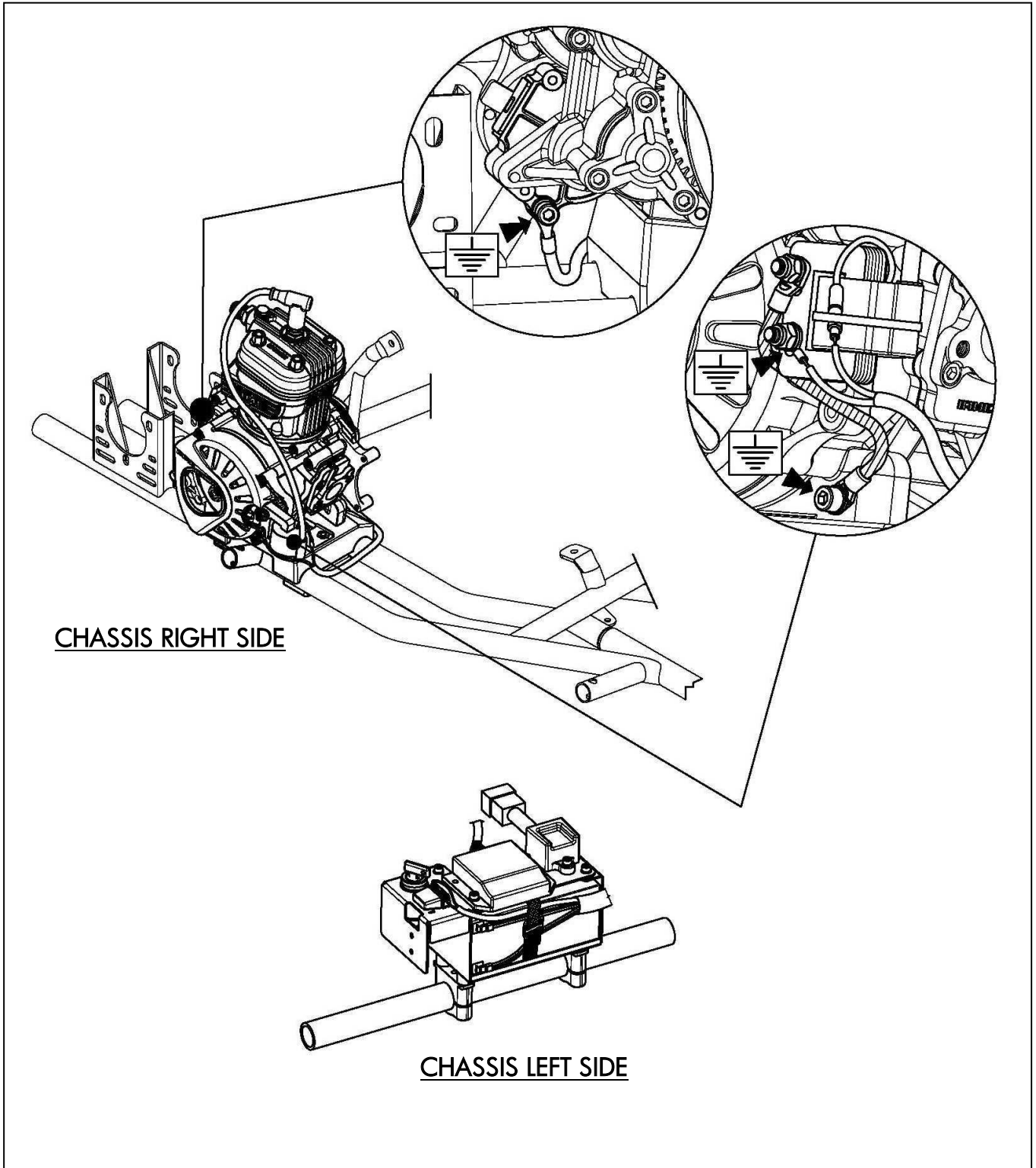

Whenever the engine or a component is disassembled, it is necessary to always follow the under shown instructions for proper reassembly.

2.1 INSTALLATION SKETCH OF THE ENGINE ON THE CHASSIS

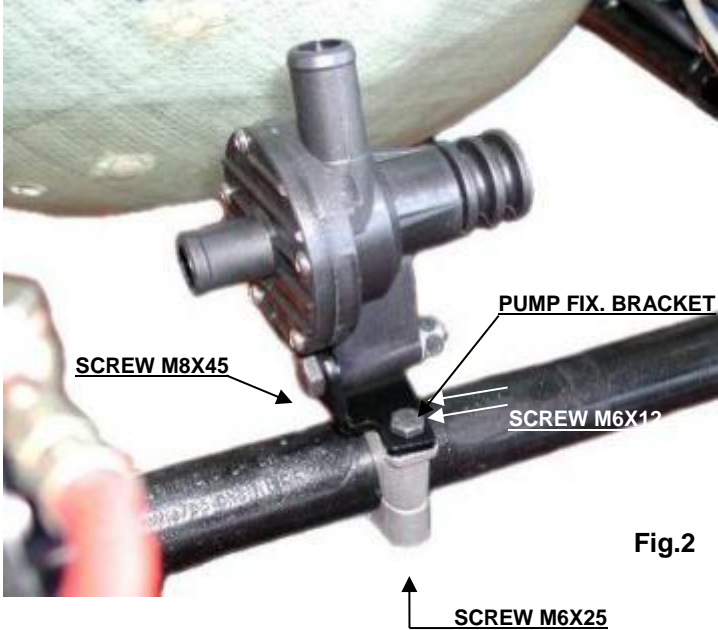

2.2 INSTALL THE WATER COOLING SYSTEM

NOTE: to install the water pump belts it is necessary to remove the rear axle.

<p>1</p>	<p>REINSTALL THE REAR AXLE AFTER HAVING INSERTED TWO BELTS.</p> <p>SUGGESTION: INSTALL TWO EXTRA BELTS AS SPARES AND FIX THEM WITH TAPE TO THE AXLE.</p>	<p>Fig.1</p> 
<p>2</p>	<p>INSTALL THE WATER PUMP (1 SCREW M8x45 WITH WASHER AND NUT) ON THE PUMP BRACKET ON THE REAR CROSS RAIL (SEE FIG. 1).</p> <p>TORQUE AT 18÷22 Nm (160 ÷190 in-lb).</p> <p>IN CASE THERE IS NO BRACKET FOR THIS PURPOSE, IT IS NECESSARY TO INSTALL THE PUMP ON REMOVABLE CLAMPS AVAILABLE IN DIFFERENT DIAMETERS (∅28/30/32mm).</p> <p>ASSEMBLE THE PUMP FIXING BRACKET ON THE CLAMP (N°2 SCREWS M6x12) AND PLACE THE CLAMPS ON THE REAR CROSS RAIL (N°2 SCREWS M6x25).</p> <p>INSTALL THE PUMP ON THE BRACKET (N°1 SCREW M8x45 WITH WASHER AND NUT – SEE FIG. 2).</p> <p>TIGHTEN BY HAND THE SCREW ON THE PUMP LETTING IT FREE TO ROTATE, FOR THE ALIGNMENT AND TENSIONING OF THE BELTS.</p>	 <p>Fig.2</p>
<p>3</p>	<p>INSTALL THE DRIVING PULLEY ON THE AXLE (2 CLAMPS AVAILABLE IN DIFFERENT DIAMETERS ∅30/35/40/50mm) ALIGNING ITS RACE WITH THE DRIVEN PULLEY ON THE PUMP (SEE FIG.3).</p> <p>FIX THE TWO CLAMPS WITH 2 SCREWS M5x22 (TIGHTEN AT 6÷8 Nm) (50 ÷ 70 in-lb).</p> <p>TIGHTEN THE TWO SCREWS M6x25 ON THE PUMP FIXING CLAMPS AND THE SCREWS M6x12 ON THE PUMP FIXING BRACKET.</p> <p>TIGHTEN AT 8÷10 Nm (70 ÷ 90 in-lb)</p>	 <p>Fig.3</p>

4

INSTALL THE BELTS AND TENSION
(SEE FIG. 4).

TIGHTEN THE SCREW M8x45.

TORQUE AT 18÷22 Nm (160 ÷190 in-lb)



Fig.4

BEFORE INSTALLING THE RADIATOR PREASSEMBLE THE FOLLOWING COMPONENTS

5

INSERT THE 4 RUBBER DAMPENERS INTO THE
FIXING HOLES ON THE RADIATOR

(SEE FIG. 5).

RUBBER DAMPENER

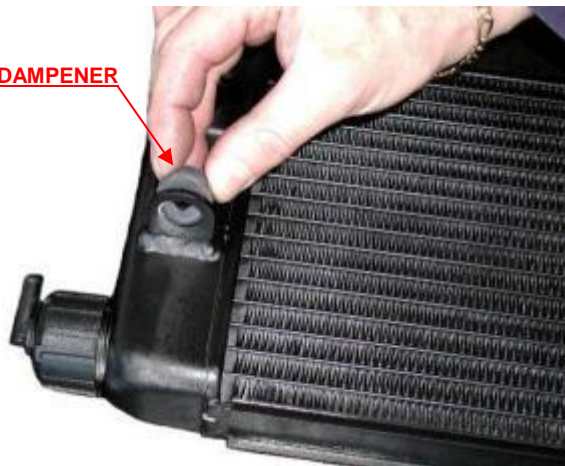

Fig.5

- PLACE THE RADIATOR SUPPORT BRACKET
BETWEEN THE RADIATOR FIXINGS BY TILTING
ONE END AND INSERTING IT THROUGH THE
RUBBER DAMPENERS

(SEE FIG. 6).

NOTE:
OIL THE BRACKET ENDS AND THE
DAMPENERS HOLES.



Fig.6

- COMPLETE INSERTION OF THE RADIATOR SUPPORT BRACKET IN THE RUBBER DAMPENERS

(SEE FIG. 7 AND 8).

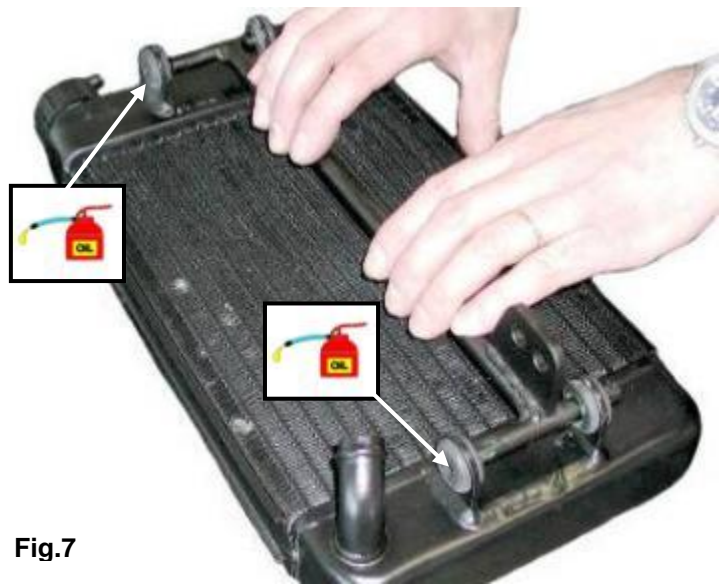

Fig.7



Fig.8

7

FIX THE RADIATOR SUPPORT BRACKET INSERTING ALSO THE RADIATOR FIXING BRACKET (RADIATOR CAP SIDE – N°1 SCREW M6x90 AND N°1 SCREW M6x85 WITH NUT). INSTALL THE "L" SHAPE BRACKET ON THE LOWER RADIATOR CLAMP (AVAILABLE IN DIFFERENT DIAMETERS \varnothing 28/30/32mm - 2 SCREWS M6x12) AND FIX IT TO THE TONGUE ON THE RADIATOR SUPPORT BRACKET (N°1 SCREW M8x20 WITH NUT)

(SEE FIG. 9).

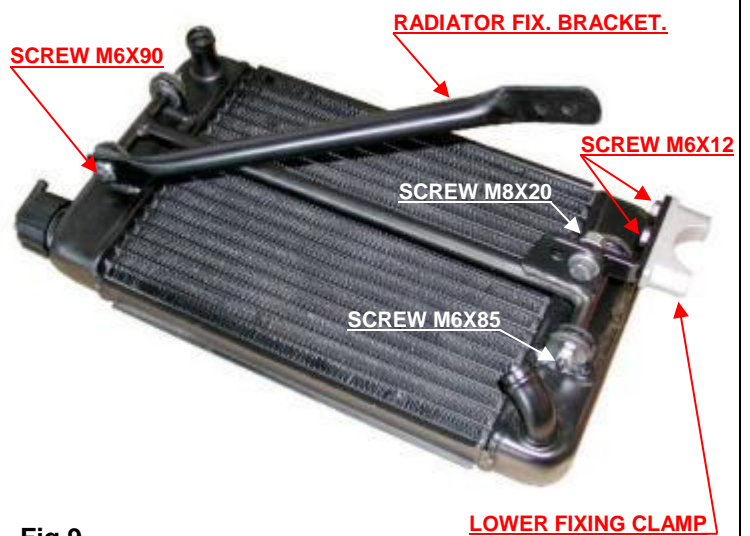

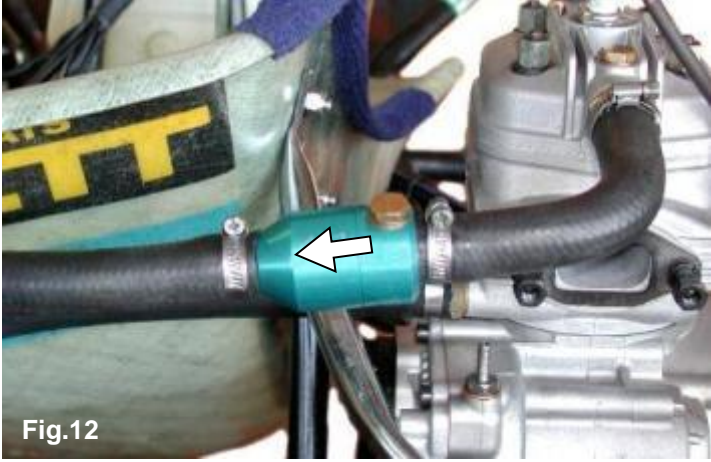

Fig.9

<p>8</p> <p>PLACE THE RADIATOR FIXING CLAMP ON THE CHASSIS SIDE RAIL (BRAKE SIDE) (N°2 SCREWS M6x25). TIGHTEN THE BOLTS BY HAND (SEE FIG. 10).</p> <p>PLACE THE RADIATOR SO THAT THE HOLE ON THE RADIATOR BRACKET AND ONE OF THE UPPER HOLES ON THE BEARING SUPPORT BOX MATCH (N°1 SCREW M8)</p> <p>ONCE YOU FIND THE CORRECT POSITION TIGHTEN THE M6x25 SCREWS ON THE LOWER CLAMP FIXING THE RADIATOR.</p> <p>TIGHTEN AT 8÷10 Nm (70 ÷90 in-lb).</p>	 <p>Fig.10</p>
<p>9</p> <p>THE KIT INCLUDES THREE RUBBER HOSES</p> <ul style="list-style-type: none"> - CONNECT THE FIRST HOSE TO THE FITTING ON THE RADIATOR INLET AND THE FITTING ON THE ENGINE OUTLET, <u>TIGHTEN WITH STEEL CLAMPS ON BOTH SIDES.</u> - CONNECT THE SECOND HOSE TO THE FITTINGS ON THE RADIATOR OUTLET AND THE PUMP INLET, <u>TIGHTEN WITH STEEL CLAMPS ON BOTH SIDES.</u> - CONNECT THE THIRD HOSE TO THE FITTINGS ON THE PUMP OUTLET AND THE ENGINE INLET. <u>TIGHTEN WITH STEEL CLAMPS ON BOTH SIDES.</u> <p>(SEE FIG. 11)</p>	 <p>Fig.11</p>
<p>10</p> <p>TO INSTALL THE THERMOSTAT REGULATING THE WATER TEMPERATURE, CUT THE HOSE CONNECTING THE FITTING ON THE RADIATOR INLET AND THE FITTING ON THE ENGINE OUTLET.</p> <p>INSTALL THE THERMOSTAT SO THAT THE ARROW IS TURNED TOWARDS THE RADIATOR</p> <p>(SEE FIG. 12)</p> <p><u>TIGHTEN WITH STEEL CLAMPS ON BOTH SIDES.</u></p>	 <p>Fig.12</p>

BEFORE STARTING THE ENGINE, FOLLOW THESE RECOMMENDATIONS:

- Unscrew the cap on the radiator and loosen the breather plug on the engine head.
- Fill the radiator until the water comes out from the plug (there is no air in the system now) and the radiator is completely filled. Tighten the cap (the system contains appr. 1 lt. of water).
- It is advisable to put a small cup to recover water from the breather on the cap in case of boiling water.
- After the engine running-in, check the water level in the radiator and top up if necessary.
- In the event of a long inactivity of the engine, remove the hoses and empty the water circuit to avoid damages to the engine or parts due to cold temperature.

2.3

EXHAUST HEADER ASSEMBLY

NOTE:
THE ENGINE IS SUPPLIED WITH THE EXHAUST GASKET AND NUTS ALREADY INSERTED. WHEN THE SHIPMENT IS MADE THE INTERNAL PARTS OF THE ENGINE ARE PROTECTED BY A BLIND GASKET. (SEE FIG. 1).

2.3.1 REMOVE THE NUTS AND THE EXHAUST COVER.

2.3.2 MAKE SURE THE EXHAUST GASKET IS IN SEAT AND INSTALL THE EXHAUST HEADER (SEE FIG 2).

2.3.3 INSTALL THE TWO WASHERS 8mm.

2.3.4 INSTALL THE TWO 2 NUTS M8.
TORQUE AT $18 \div 22 \text{ Nm}$ ($160 \div 190 \text{ in-lb}$)

Fig.1

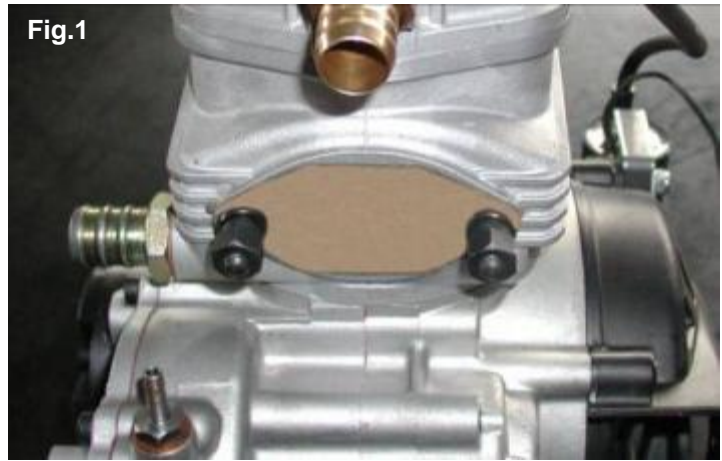

Fig.2



13mm SOCKET WRENCH OR (13 mm OPEN WRENCH)

2.4

PREPARATION AND INSTALLATION OF THE MOTOR-MOUNT

NOTE: ALL THE DIMENSIONS ARE IN MILLIMETERS

2.4.1 DRILL 4 HOLES (DIAM. $8.25 \div 8.5 \text{ mm}$) IN THE MOTOR-MOUNT.

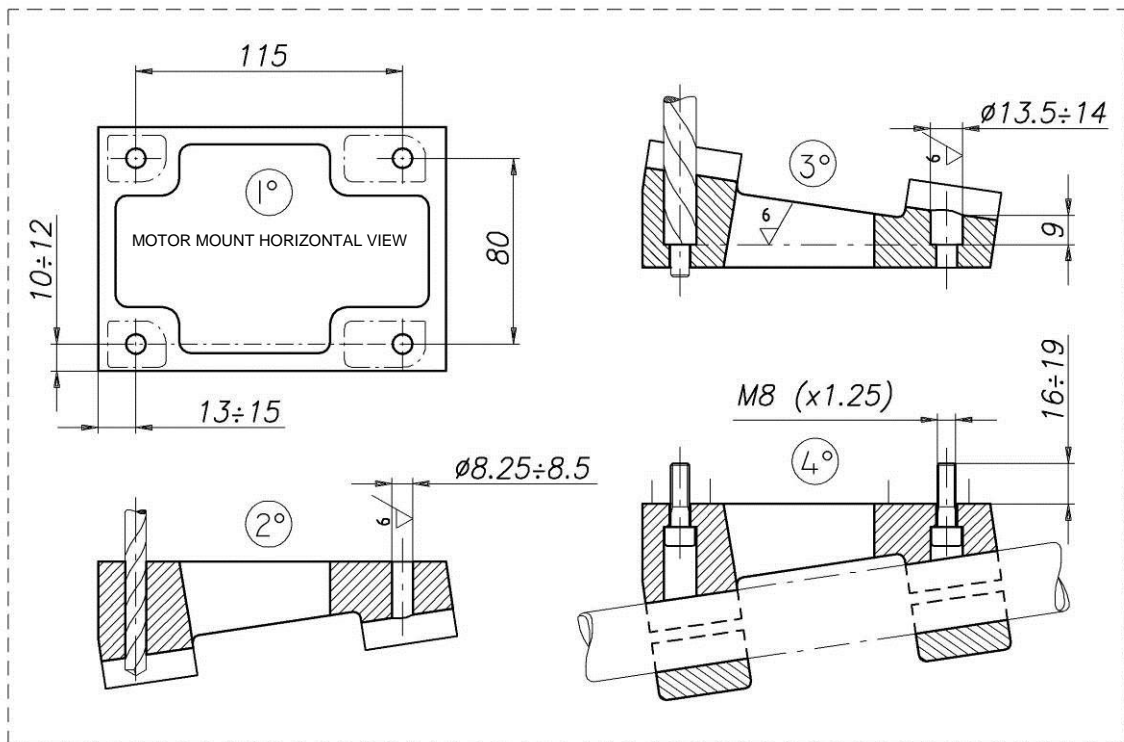

2.4.2 INSTALL THE MOTOR-MOUNT, MAKE SURE TO USE THE M8 ALLEN SCREWS, WITH A LENGTH SUCH AS TO ENGAGE, IN THE CRANKCASE, A THREADED LENGTH OF 16÷19mm (THE SCREW MUST PROTRUDE FROM THE PLATE FOR 16÷19mm).

(SEE FIG. 3 AND DRAW. PAG. 11)

4 ALLEN SCREWS M8

TORQUE AT 22÷24 Nm (190 ÷ 210 in-lb)

6 mm ALLEN WRENCH

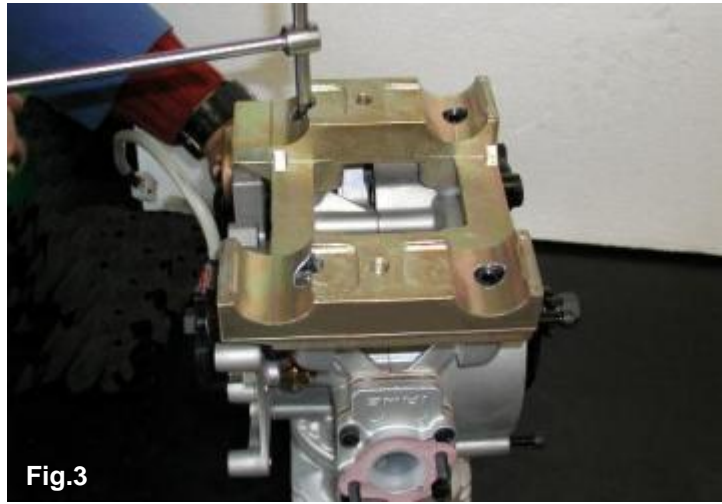

2.5 INSTALL THE CARBURETOR

2.5.1 REMOVE THE PLASTIC PLUG FROM THE INLET MANIFOLD

(SEE FIG. 4).



WARNING:
MAKE SURE THAT THE PRESSURE HOLE ON THE GASKET IS NOT PLUGGED.

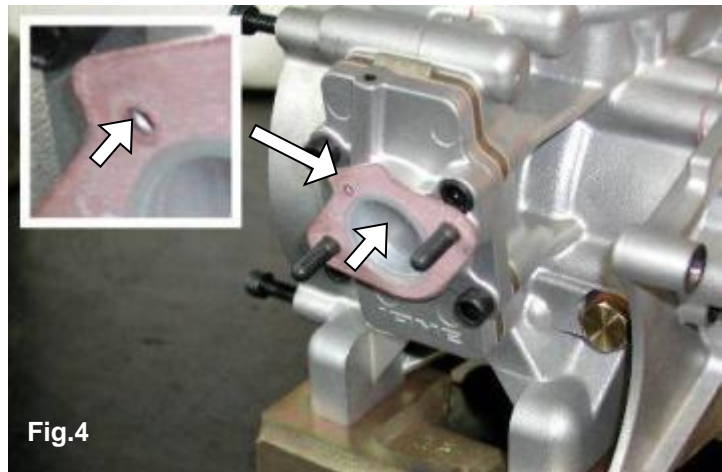





2.5.2 INSTALL THE CARBURETOR.
TWO 2 NUTS M6 AND TWO WASHERS
(SEE FIG. 5).
TORQUE AT 6 ÷ 10 Nm (50÷ 90 in-lb)



WARNING:
WHEN REPLACING THE CARB GASKET ALWAYS MAKE SURE THAT THE GASKET IS INSTALLED SO THAT THE HOLE IN THE GASKET MATCHES WITH THE TWO PRESSURE HOLES IN THE CARB. AND IN THE CRANKCASE: OTHERWISE THE ENGINE WON'T START.

5 mm ALLEN

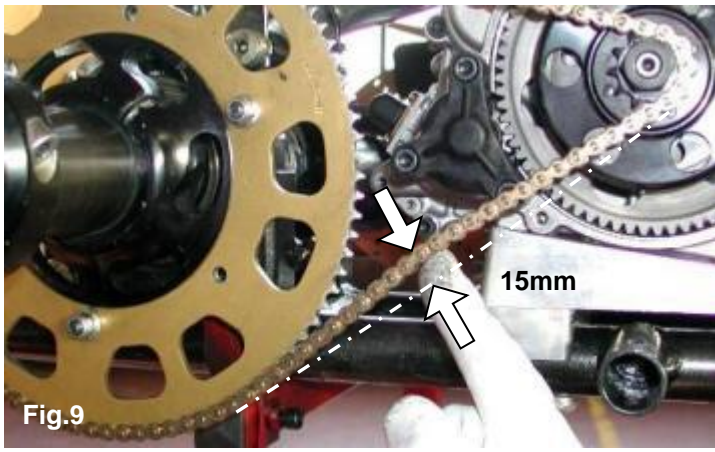

<p>2.6 INSTALL THE ENGINE ON THE CHASSIS</p> <p>2.6.1 POSITION THE ENGINE ON THE TWO OUTSIDE MAIN RAILS AND FIX THE MOTOR-MOUNT WITH TWO CLAMPS.</p> <p>(SEE FIG. 6)</p> <p>SUGGESTION: NEVER TORQUE COMPLETELY THE CLAMPS UNTIL THE CHAIN IS INSTALLED AND PROPERLY ALIGNED.</p>	 <p>Fig.6</p>
<p>2.6.2 CHECK THE ALIGNMENT OF THE ENGINE SPROCKET AND THE AXLE SPROCKET WITH A STRAIGHT EDGE.</p> <p>(SEE FIG. 7)</p>	 <p>Fig.7</p>
<p>2.6.3 INSTALL THE CHAIN (PITCH: 7.775)</p> <p>(SEE FIG. 8)</p>	 <p>Fig.8</p>
<p>2.6.4 MOVE THE ENGINE ON THE RAILS AND OPTIMIZE THE CHAIN TENSION.</p> <p></p> <p>WARNING: <i>THE PLAY OF THE CHAIN MUST BE APPR. 15mm (1/2+3/4). MEASURED IN THE SHOWN POINT (SEE FIG. 9).</i></p>	 <p>Fig.9</p>
<p>2.6.5 TORQUE THE CLAMP SCREWS</p>	

2.7 INSTALL THE CLUTCH COVER WITH H.T. COIL

2.7.1 REMOVE THE 3 SCREWS M6x25 ON THE CRANKCASE (SEE FIG.10) AND INSTALL THE CLUTCH COVER WITH H.T. COIL. (SEE FIG.11).

TORQUE THE 3 SCREWS AT $8 \div 10$ Nm ($70 \div 90$ in-lb).

NOTE:
IF AN HORIZONTAL MOTOR-MOUNT IS USED CHECK AND SEE IF THERE IS SUFFICIENT SPACE BETWEEN THE CHAIN AND THE UPPER PART OF THE CLUTCH COVER. IF THIS IS LOWER THAN $6 \div 7$ mm WIDEN THE CHAIN OPENING WITH A FILE . TO CHECK THIS WE SUGGEST TO INSTALL THE SPROCKET WITH THE HIGHEST AVAILABLE TOOTH NUMBER

5 mm ALLEN

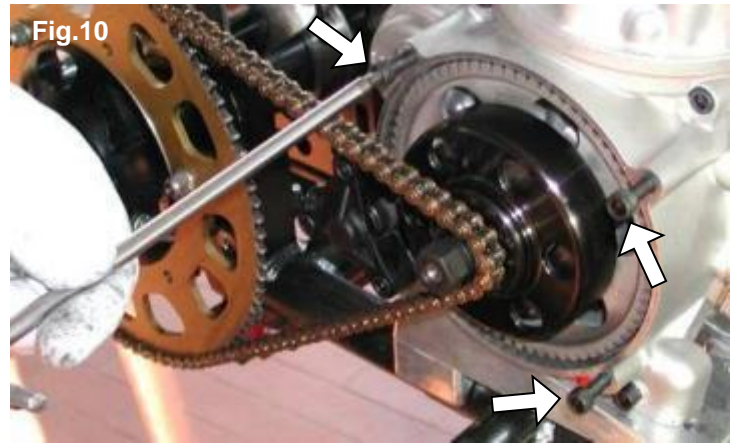

2.7.2 CONNECT THE COIL COPPER CABLE ON THE HOLE ON THE CRANKCASE (SCREW M6x12

(SEE FIG. 12).

TORQUE AT $8 \div 10$ Nm ($70 \div 90$ in-lb)



WARNING:
ALWAYS MAKE SURE THAT THE GROUND CABLE ALWAYS CONNECTS THE COIL WITH THE ENGINE. AN INADEQUATE GROUNDING COULD DAMAGE THE IGNITION BEYOND REPAIR.

THE POSITION OF THE H.T. COIL HAS BEEN CHOSEN TO BE AS FAR AS POSSIBLE FROM THE EXHAUST AS THE EXCESSIVE HEAT COULD DAMAGE THE COIL BEYOND REPAIR.

5 mm ALLEN

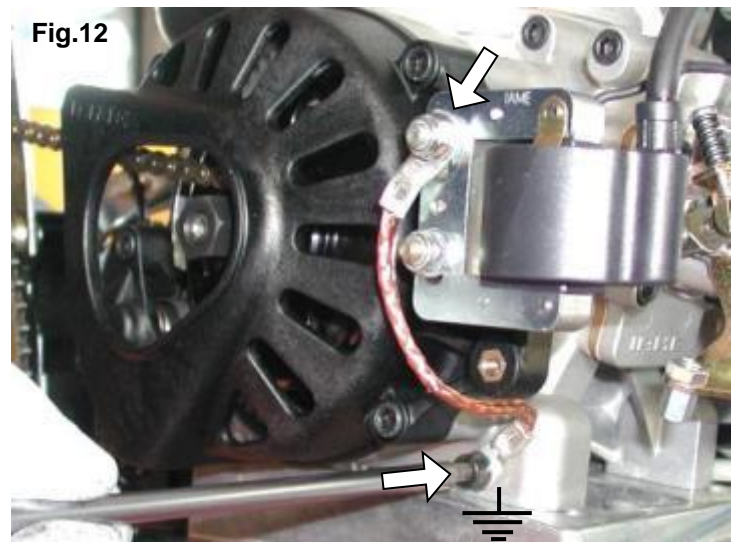

2.8 MOUNTING OF THE ELECTRIC PLANT AND CONNECTORS
(complete scheme in the drawing at the end of the document)

NOTE:
For a correct installation follow the under shown instructions.

MOUNT THE SILENT BLOCKS ON THE UPPER CLAMP (FIG. 13).



Fig.13

COMPLETE THE MOUNTING OF THE CLAMPS ON THE BATTERY SUPPORT WITH THE N°4 SCREWS M6x25, N°2 SCREWS FOR EACH CLAMP (FIG. 14).

TORQUE AT 6 ÷ 8 Nm (50÷ 70 in-lb)

WRENCH 4mm



NOTA:
THE DIFFERENT HOLES ON THE SUPPORT ALLOW TO ADAPT THE THE SYSTEM TO ALL CHASSIS.

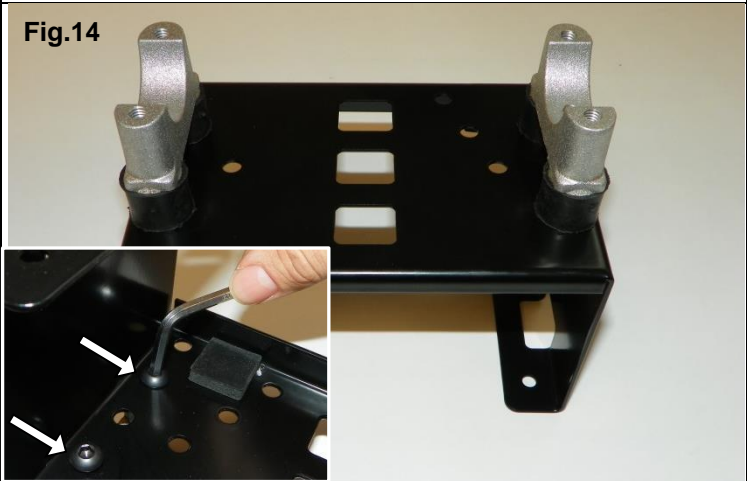

Fig.14

PLACE THE SUPPORT PLATE ON THE SUPPORT AND FIX THROUGH THE N°3 SCREWS M5x10 AND CONCERNED WASHERS AND NUTS.

TORQUE AT 6 ÷ 8 Nm (50÷ 70 in-lb)

WRENCH 4mm

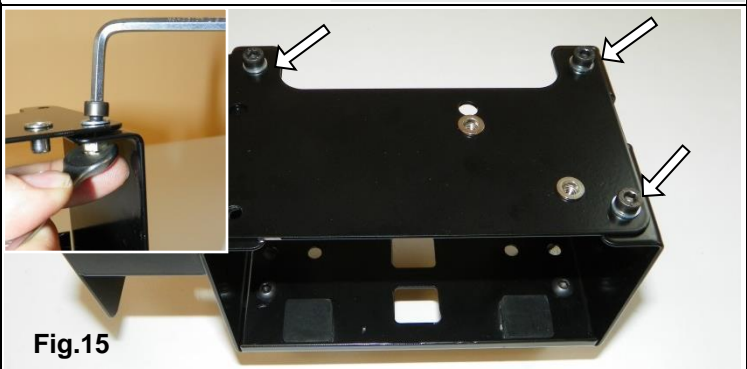

Fig.15

PLACE THE ELECTRONIC BOX ON THE PLATE AND FIX IT THROUGH THE N.2 SCREWS M5x15 E AND CONCERNED WASHERS AND SELF LOCKING NUTS.

TORQUE AT 6 ÷ 8 Nm (50÷ 70 in-lb)

WRENCH 4mm



WARNING:
THE CABLES HARNESS DOESN'T HAVE TO GET IN CONTACT WITH THE SOIL OR WITH ROLLING PARTS TO AVOID IRREPARABLE DAMAGES.

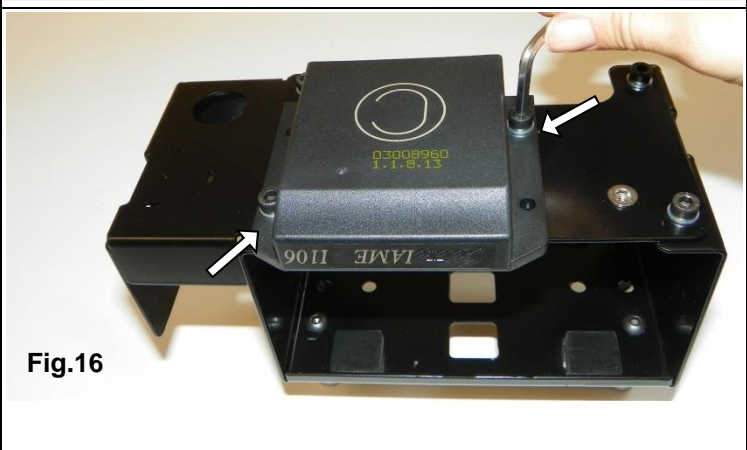

Fig.16

DRILL A HOLE (Ø6mm) IN THE FRONT PART OF THE RELAY BOX AS SHOWN IN THE PICTURE AND FIX THE RELAY THROUGH THE SCREW M5x20 WITH WASHER ON THE PLATE. (Fig. 17)

TORQUE AT 6 ÷ 8 Nm (50÷ 70 in-lb)

WRENCH 4mm



Fig.17

PLACE THE PLASTIC CLAMPS IN THE DEDICATED HOLES AND PUT THE FUSE HOLDER IN POSITION AND THEN TIGHTEN THE PLASTIC CLAMPS TO FIX THE FUSE CASE. CUT OFF EXCEEDING PLASTIC CLAMPS.

(Fig.18)

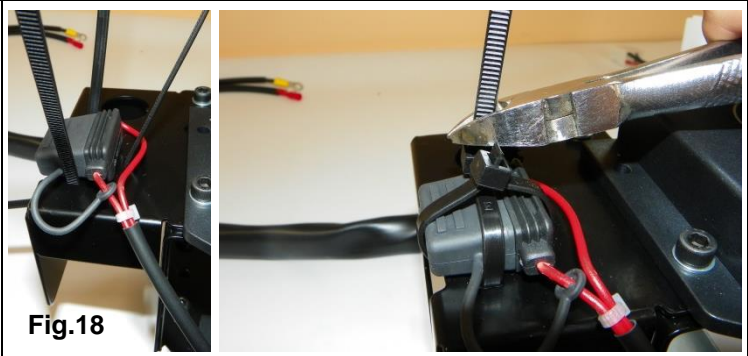

Fig.18

MOUNT THE KEY BLOCK IN THE DEDICATED HOUSING.

(Fig.19)

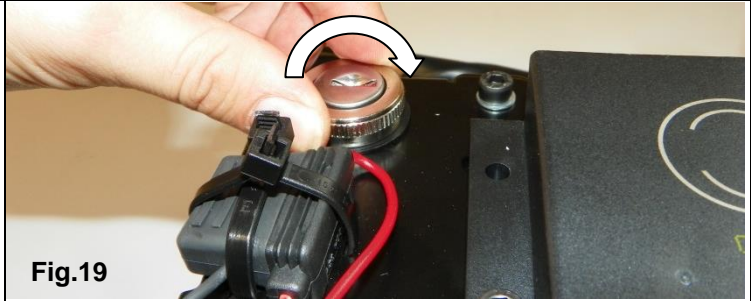

Fig.19

SLIDE THE BATTERY FIXING STRIPE IN THE DEDICATED SLOTS.

(Fig.20)

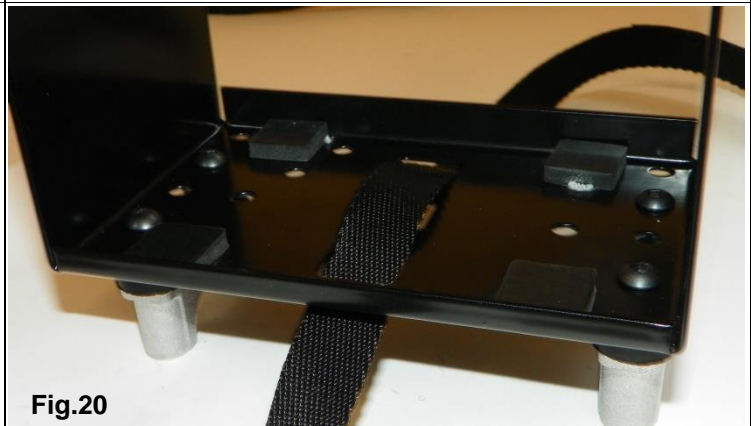

Fig.20

PLACE THE BATTERY IN THE DEDICATED SLOT.

(Fig.21)



Fig.21

PLACE THE CABLES AT DESIRED CONVENIENCE, IN A PRACTICAL AND SAFE WAY AND TIGHTEN THE BATTERY STRIPE.

ADVICE:
CONNECT THE BATTERY ONLY BEFORE STARTING THE ENGINE.
PROTECT THE CONNECTIONS ON THE BATTERY WITH ISOLATING TAPE TO AVOID ACCIDENTAL RELEASE OF THE FASTONS.

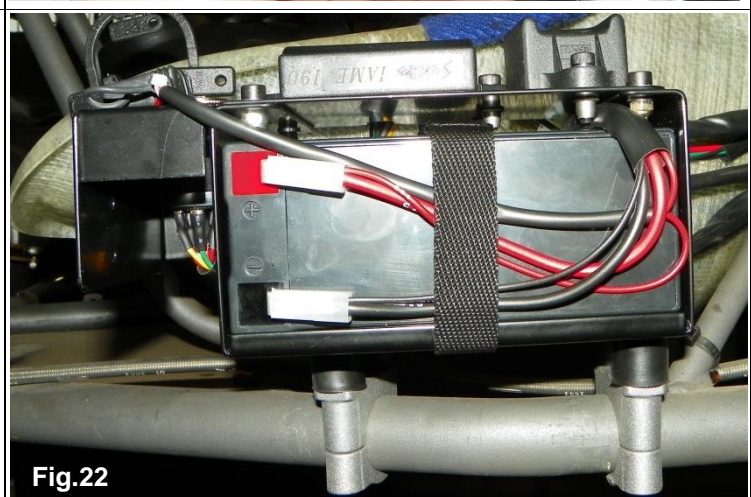
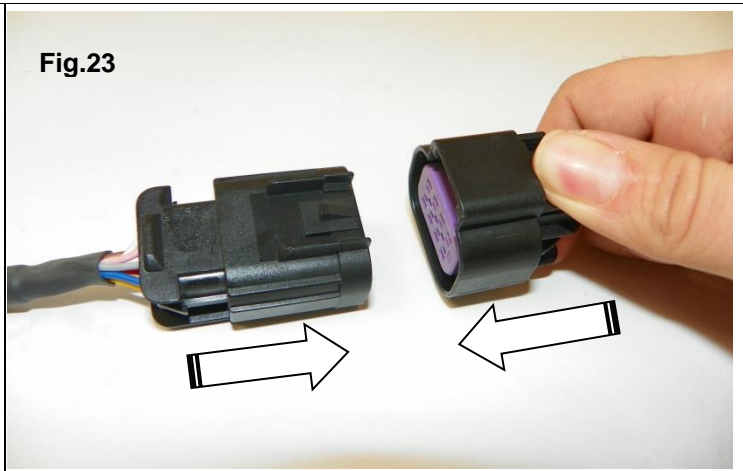

Fig.22

CONNECT THE STATOR PIN WITH THE PIN ON THE CABLES HARNESS.

(FIG. 23)

Fig.23



CONNECT THE STARTER MOTOR PIN WITH ITS CORRESPONDING ON THE CABLES HARNESS.

(FIG. 24).



WARNING:
MAKE SURE THAT THE SECURITY FLAPS SNAP TO GUARANTEE THE CORRECT CONTACT OF THE TWO ENDS AND A SAFE TIGHTENING.

Fig.24

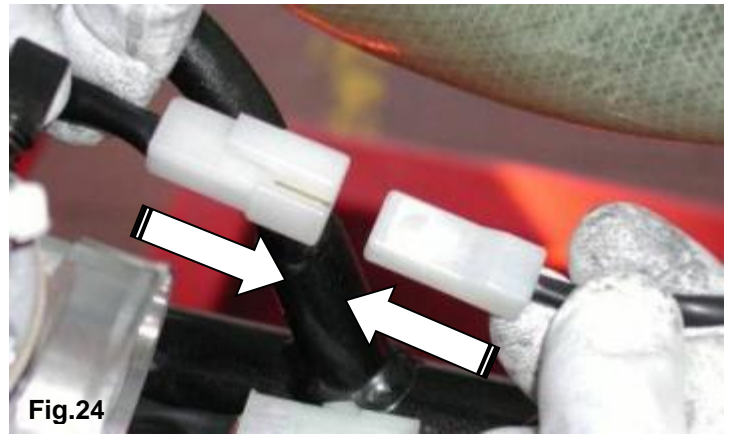

VERIFY THE PRESENCE OF THE PLASTIC CLAMP ON THE STARTER MOTOR AND THAT IT FIXES THE CABLE ON THE BODY OF THE STARTER ENGINE.

(FIG. 25).



WARNING:
THIS OPERATION IS VERY IMPORTANT AS THE VIBRATIONS COULD CAUSE DAMAGES TO THE INTERNAL STARTER MOTOR CONNECTIONS.

Fig.25

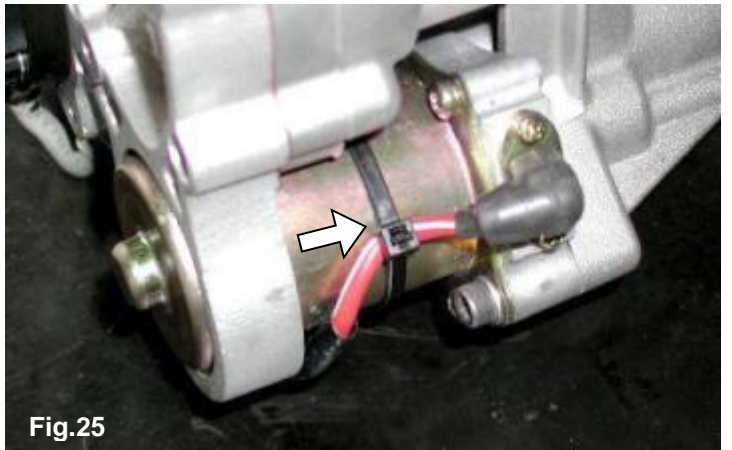

PLACE THE GROUND CABLE BUTTONHOLE END (Ø 6.5mm) ON THE BACK OF THE ENGINE.

(FIG. 26).

Fig.26



FIX THE BUTTONHOLE END OF THE GROUND CABLE THROUGH THE M6x12 SCREW PRESENT ON THE STARTER ENGINE.

(FIG. 27)

TORQUE AT 8 ÷ 10 Nm (70÷ 90 in-lb)



WARNING:
THIS OPERATION IS FUNDAMENTAL AS AN IMPROPER GROUNDING COULD IRREPARABLY DAMAGE THE CELECTRONIC BOX.

ALLEN WRENCH 5 mm

Fig.27

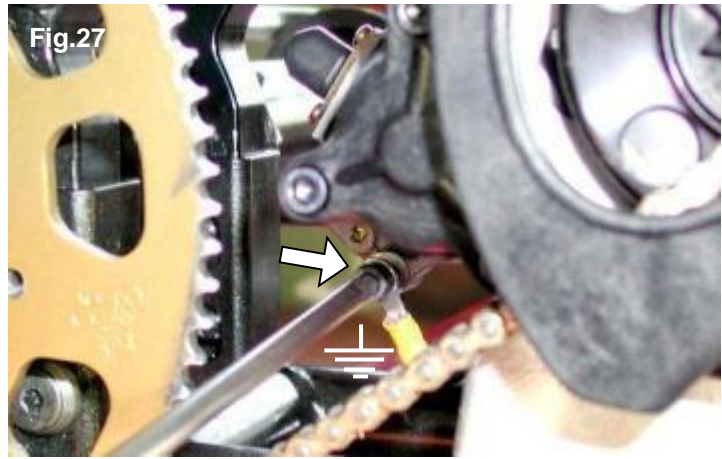

FIX THE BUTTONHOLE END OF THE SECOND GROUND CABLE TO THE H.T. COIL THROUGH THE M6 NUT OF THE H.T. COIL.

(FIG. 28).

TORQUE AT 8 ÷ 10 Nm (70÷ 90 in-lb)



WARNING:
THIS OPERATION IS FUNDAMENTAL AS AN IMPROPER GROUNDING COULD IRREPARABLY DAMAGE THE CELECTRONIC BOX.

TUBE KEY 10mm

Fig.28



CONNECT THE PIN OF THE CABLE OF DELIVRED BY THE H.T. COIL TO THE CABLE COMING FROM THE CABLES HARNESS.

(FIG. 29)



WARNING:
USE A PLASTIC CLAMP TO FIX THE CABLE ON THE H.T. COIL TO AVOID THE ACCIDENTAL RELEASE OF THE PINS.

(FIG. 30)

Fig.29

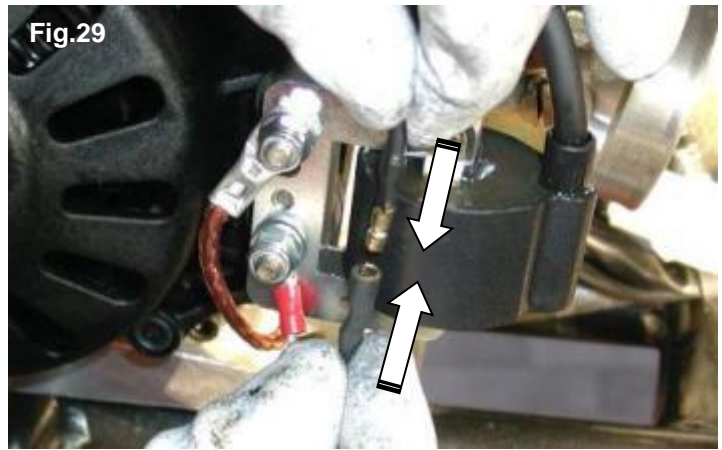

Fig.30



CONNECT THE ELECTRONIC BOX TO THE 20 POLES CONNECTOR OF THE CABLES HARNESS.

(FIG. 31)

CONNECT THE STARTER RELAY TO THE 4 POLES PIN ON THE CABLES HARNESS.

(FIG. 32).



WARNING:
MAKE SURE THAT THE SECURITY FLAPS SNAP TO GUARANTEE THE CORRECT CONTACT OF THE TWO ENDS AND A SAFE TIGHTENING.

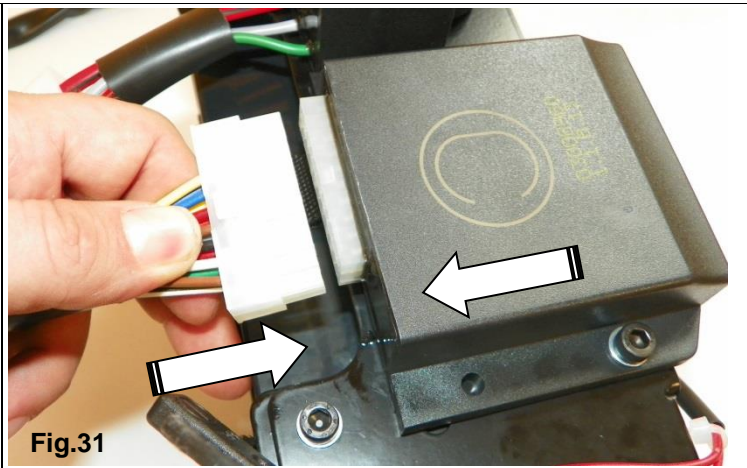

Fig.31

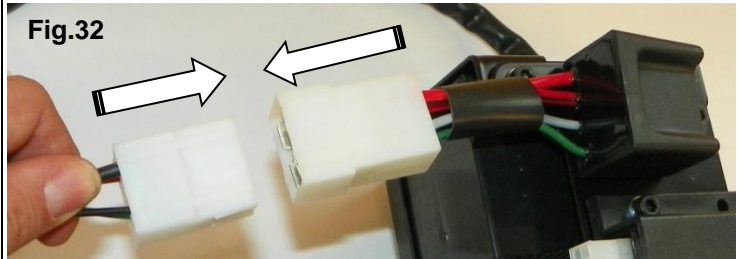

Fig.32

CONNECT THE PIN OF THE KEY BLOCK TO THE 8 POLES PIN FROM THE CABLES HARNESS

(FIG. 33)



WARNING:
MAKE SURE THAT THE SECURITY FLAPS SNAP TO GUARANTEE THE CORRECT CONTACT OF THE TWO ENDS AND A SAFE TIGHTENING.

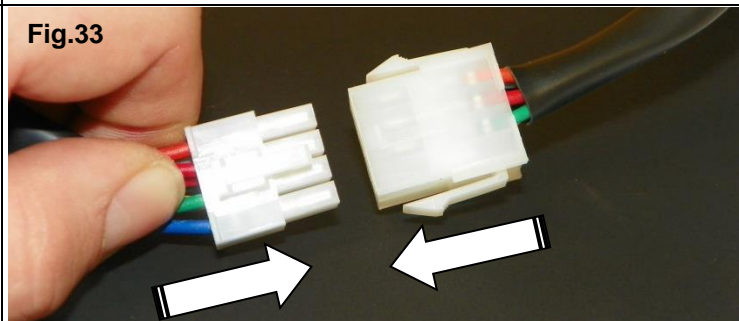

Fig.33

SCREW THE SPARK PLUG CAP ON THE H.T. COIL CABLE.

(FIG. 34)

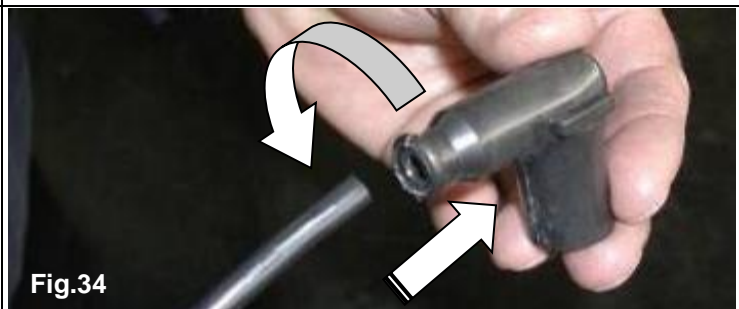

Fig.34

FIX THE SPARK PLUG CAP ON THE H.T. COIL CABLE WITH A PLASTIC CLAMP.

(FIG. 35)

- MOUNT THE SPARK PLUG PROVIDED WITH THE ENGINE AND **TORQUE A 20 ÷ 26 Nm (175÷ 230 in-lb)**
- PLACE THE SPARK PLUG CAP ON THE SPARK PLUG.



Fig.35

2.9

INLET SILENCER MOUNTING



MAKE SURE THAT THE INTAKE SILENCER IS POSITIONED WITH THE HOLES UPSIDE AND THAT THEY ARE NOT OBSTRUCTED.

TIGHTEN THE CLAMP ON THE CARBURETTOR AND FIX THE INLET SILENCER WITH THE DEDICATED CLAMP ON THE CHASSIS TUBE.

(FIG. 36)

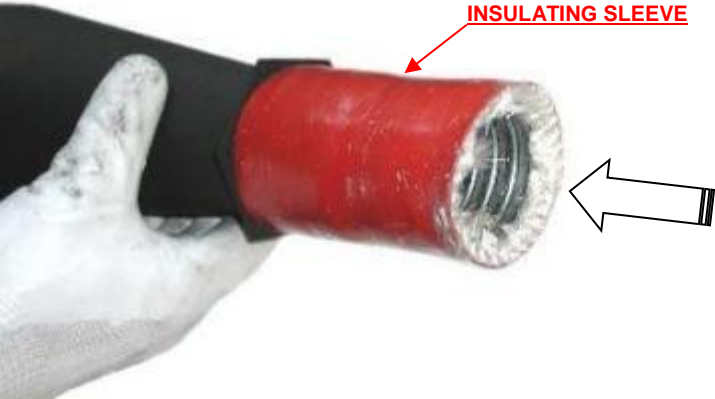

Fig.36

<p>2.10 INSTALL THE EXHAUST</p> <p><i>NOTE:</i> SEE SECTION 3.8 FOR THE RECOMMENDATIONS ON THE IDEAL EXHAUST LENGHT.</p>	
<p>2.10.1 INSTALL THE FLEXIBLE (L= 65mm FLEXIBLE COMPLETELY CLOSED -) AND THE EXHAUST HEADER (SEE FIG. 37) AND FIT THE INSULATING SLEEVE ON THE FLEXIBLE (SEE FIG. 38)</p>	<p>Fig.37</p>  <p>Fig.38</p> 
<p>2.10.2 INSERT THE FLEXIBLE ON THE EXHAUST HEADER AND FIX WITH THE 3 SPRINGS (SEE FIG. 39)</p>	<p>Fig.39</p> 

THE ENGINE IS READY TO BE STARTED

Section 3 - USE OF THE ENGINE

3.1 CHARGING OF THE OIL IN THE GEARBOX



WARNING:

The engine is supplied without oil in the gear box. Before starting the engine fill the box with SAE 30 oil.

Starting the engine with a dry box will damage the gears beyond repair

- Charge of the gear box:

Put the engine in horizontal position, unscrew the oil plug (n°1 on the picture), and oil level plug (n°2 on the picture), fill with oil until it comes out from the oil level plug (appr. 40cc of oil).

Use a SAE 30 motor oil.

- Check the oil level

Put the engine in horizontal position and unscrew the oil level plug.

If the level is correct you should see a light outcome of oil, otherwise top up.

- Discharge the oil

Unscrew the oil level plug and loosen the charge plug. Tilt the engine to discharge the oil through the oil level plug.

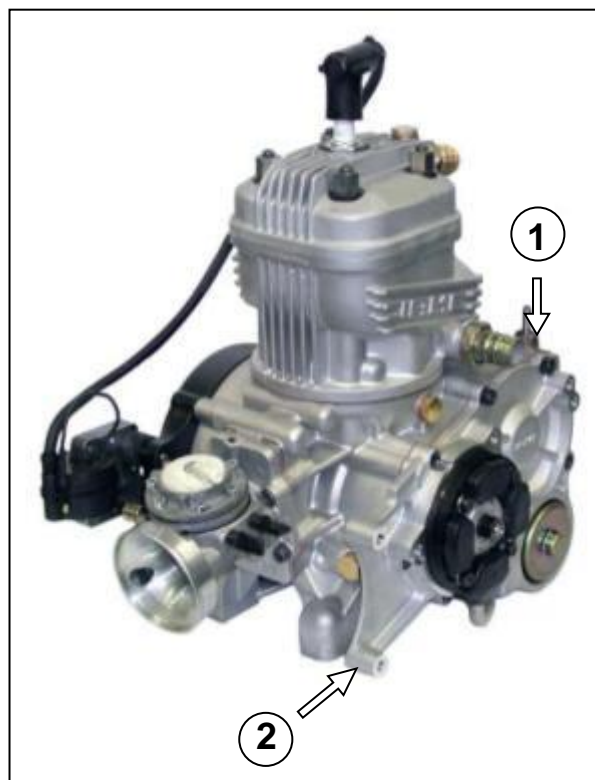

3.2 GASOLINE AND OIL

Use leaded or unleaded Premium gasoline 95 ROM, mixed with oil at 4% (25:1).

Use oils containing Castor Oil which guarantees an optimized lubrication at high temperature.

As on the other hand, use of Castor Oils creates gummy residues which give origin to carbon deposits, it is necessary to check and clean, at least every 5 ÷ 10 hours, the piston and the head.

Our experience dictates use of oils, such as:

- SHELL ADVANCE RACING M
- ELF HTX 909
- ERG K KART FORMULA

Once the fuel tank is filled, make sure that the gasoline reaches the carburetor before starting the engine.

Never use the electric starter to suck the gasoline as this could discharge the battery.

SUGGESTION:

Disconnect the plastic tube on the carb. and the vent tube on the tank and pressurize the vent tube, until the gasoline comes out from the tube on the carb. Make sure that there is no air in the tube. Connect the tube on the carb. and on the vent.

3.3 CARBURETOR ADJUSTMENT GUIDE

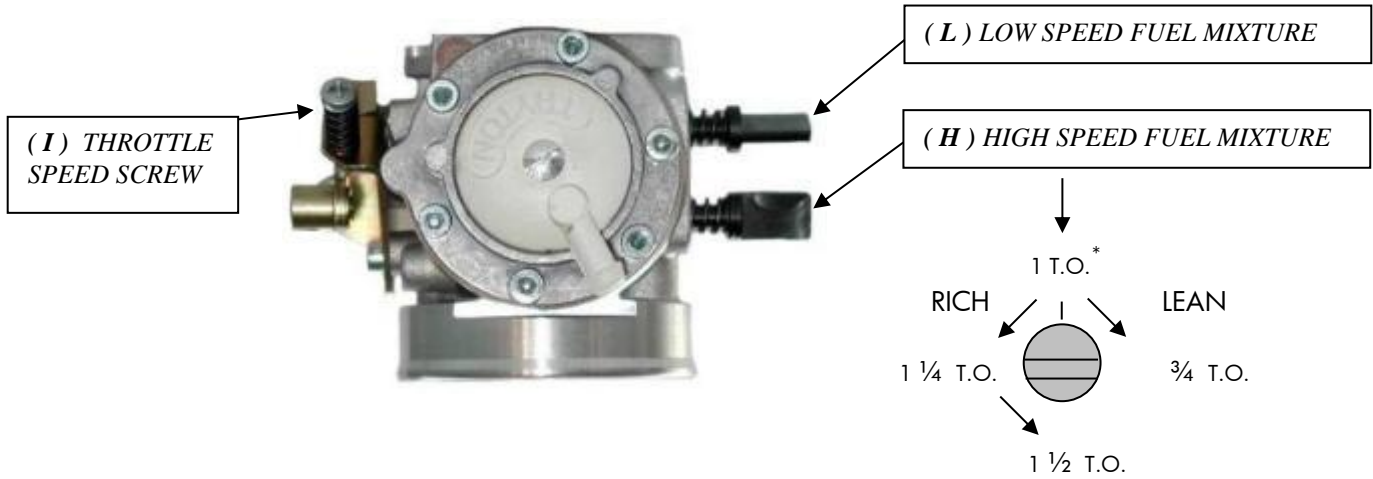

* T.O. = TURNS OPEN

Normally the correct setting of the mixture screws, after engine run-in, is the following:

- L (close the screw completely and then open): 1 T.O. (1 turn)
- H (close the screw completely and then open): 1 1/6 T.O. (1 turn and 10')

Based on various factors such as altitude, ambient temperature etc. It might be necessary to reset the carburetor to optimize the performance of the engine.



WARNING:

Never lean too much as lean mixture will overheat engine and cause seizure

Do not force H or L closed. It may damage the precision machined orifice and render the carb. in-serviceable.

The adjustment of screw must be performed with warm engine.

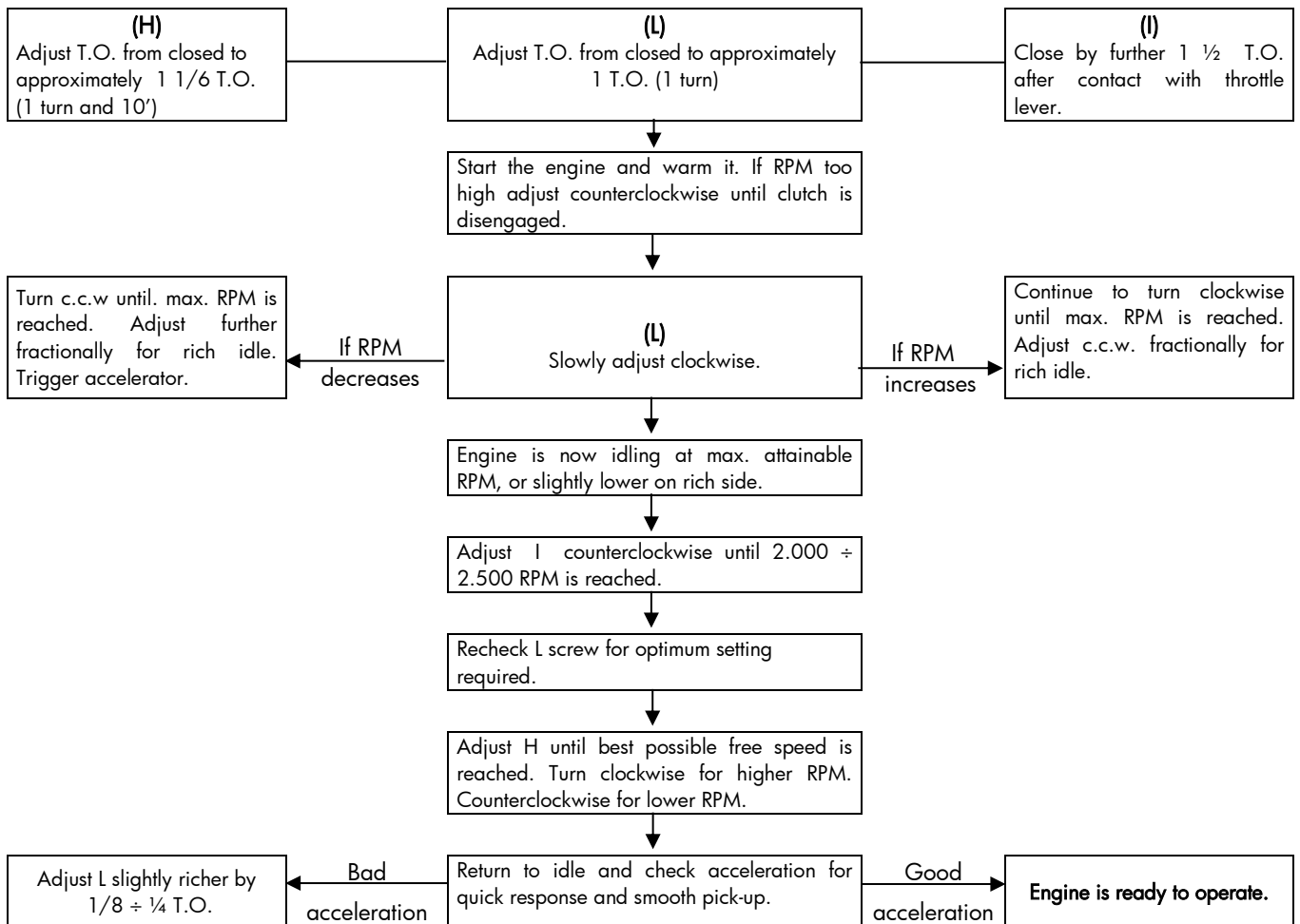

3.4 STARTING AND STOPPING THE ENGINE

Starting is achieved by the starting key.

This is a 3 position key:

- 1- STOP (key can be removed)
- 2- KEY
- 3- RUN

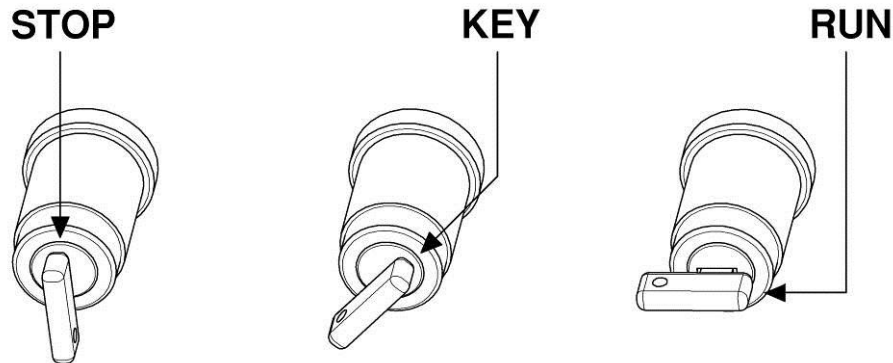

In STOP position the battery is disconnected and the engine stop signal is sent to the electronic box.

In KEY position the battery is connected to the system and the stop signal is removed. In RUN position the battery is always connected and the electric starter, operation signal is sent to the electronic box.



WARNING:

The starting key assembly is supplied with two original keys. We recommend to separate the keys and to keep one in a protected place. In case of loss of both keys, it is necessary to replace the complete assembly.

The starting procedure, from STOP position, is as follows:

- A) Turn the key to KEY position (this connect the battery).
- B) Turn the key to RUN position to start the engine (the electric starter is immediately disengaged when turning the key to KEY position, or when the electronic box detects an engine RPM higher than 1.500 RPM).
- C) When the engine is running, the key can be left both in the RUN or KEY position. We suggest, for practical reasons, to turn the key to KEY position; this allows with a single tripping to stop the engine (STOP position) or to restart it in case the engine is stopped (RUN position).

Note:

- ***in case the engine is stopped with the key in RUN position, to restart it, turn the key to STOP position and then again to KEY and RUN position to activate the electric starter.***
- ***With the key in KEY or RUN position and if the engine is stopped, to start the engine an external starter unit can also be used.***

In case the engine cannot be started within 5 seconds (check that gas gets to the carb.) interrupt and try again after 15 seconds. Short and frequent tries are better than long ones.

To stop the engine turn the key to STOP position both from KEY (1 tripping) or from RUN (2 trippings).

3.5 ENGINE RUNNING-IN

The running-in of the engine must be performed following a few fundamental rules:

1. Adjust the carburetion. Start with an adjustment on the rich side.
2. Warm the engine gradually for about 5 minutes at half throttle, making some laps at low speed, gently closing and opening the carb. throttle (if a tachometer is installed never exceed 11.000 ÷ 12.000 RPM). **Never keep the same RPM for a long time.**
3. Increase the speed for 5 minutes at $\frac{3}{4}$ throttle opening.
Never keep the same RPM for a long time.
4. Increase the speed for 5 minutes, at max. speed on the twisty parts of the circuit and making the engine rich at half straight (cover with the hand for **an instant** the holes on the inlet silencer keeping the throttle wide open).



WARNING:

Once the running-in is over and the engine is cold, check the torque of the exhaust header nuts as, during the running-in, the nuts tend to become loose (refer to the attached table).

3.6 RPM LIMITATION

The electronic box incorporates an RPM limiter which prevents the engine from exceeding 14.000, 15.500 or 16.000 RPM, depending on the engine versions. This limit cannot be exceeded otherwise the engine could be damaged by the extremely high RPM.



WARNING:

Do not keep the engine for a long time at the RPM at which the limiter is functioning. This would cause malfunctions on the induction and damage the reed valve.

When choosing the sprocket ratio always refer to a maximum limit which has to be equal to the engine version max rotation limit (i.e. 14.000, 15.500 or 16.000 RPM), so that the incorporated limiter is not switched on continuously when the engine is running.

3.7 INLET SILENCER

Make sure that the inlet holes on the filter are towards the upper side and that they are not plugged. Make sure that the clamp on the carburetor is not loosen and that the filter is well fastened to the chassis.

Regularly clean the inside from oil deposits. If necessary remove the rubber manifold with filter and clean it with gasoline or solvent.

3.8 EXHAUST SYSTEM

Before each test, make sure that the flexible is not damaged. Replace if necessary.



WARNING:

In case the flexible is damaged, metallic particles could be sucked in the engine and cause a seizure.

Always make sure that the springs are well hooked and in place. In case of breakage, replace the broken spring. **Never race the kart without the 3 springs in place**, as otherwise the exhaust pipe could vibrate beyond control.

Every 10 ÷ 15 hours, open the pipe end and make sure that the holes on the internal counter cone are not plugged.

The best performance is achieved with a total exhaust length of:

$$L = 450 \div 455 \text{ mm.}$$

Where L is measured from the flange on the exhaust header up to the first welding on the first cone of the exhaust muffler (see drawing).

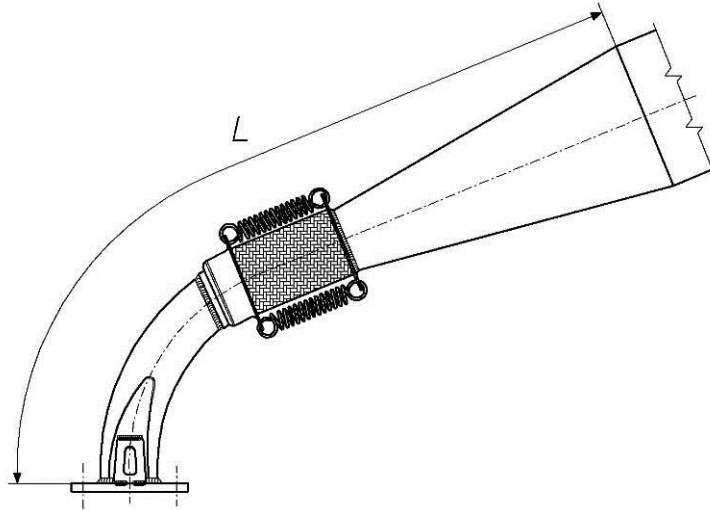

To achieve this dimension, the flexible (supplied with the engine) must be cut at a length of 65mm (flexible completely closed).

Having fixed a sprocket ratio, it could be necessary to improve the engine performance either at low or at high RPM.

This could be achieved by modifying the exhaust length.

In general, by shortening the total exhaust length the low RPM an improvement at high RPM is achieved and vice versa, by lengthening the exhaust length the low RPM is improved.

When testing, never exceed in lengthening or shortening the flexible by more than 5mm per time.

3.9 BATTERY

The battery (12 V – 9 Ah) is sealed and without maintenance (battery not included in the engine package).

In order to lengthen the battery life it is recommended to follow few suggestions:

- When the tension drops below 12.6V. it is necessary to recharge the battery.
- Max. allowed recharging current is 1.8A.
- The ideal recharge is achieved with an average charging current of $0.8 \div 1$ A. (recharging time of appr. 10 h.) and at an ambient temperature between 0° and 40°C.



ATTENTION:

An overcharge or an extremely quick charge with excessive current could damage the battery (the battery would tend to swell).

Choose a battery charger with the following characteristics:

- Feed tension: 90/250 Vac – 50/60 Hz
- Outlet tension: 15 V full charge – 13.8 stand-by
- Max. outlet current: 2A full charge

During transportation or storage, the battery could loose its charge due to the self discharge (0.1% max per day).

Fully recharge battery before use.



WARNING:

Always connect the - (negative) terminal before and the pole + (positive terminal after).
Always disconnect the battery in opposite order.

- Recharge the battery at least once every 6 months.
- Never let the battery tension dropping under 8V, as whenever it drops under this limit, the battery cannot be used any longer and it has to be replaced.
- Never put the battery in contact with solvents, oils, plastifiers or rags containing such elements. The external case of the battery could be damaged.
- Never press or bend or overheat (by welding) the battery terminals.

Other recommendations

- Pay attention not to have free fires upon or around the battery.
- Never short-circuit the terminals.
- Never open the battery or throw it in the fire.
- In case the electrolyte (diluted Sulfuric Acid) gets in contact with skin or clothes, wash immediately with water. In case it gets in touch with eyes, wash and apply for medical assistance.
- Carefully check the external case of battery and replace in case of breakages, swellings of the case or of battery cover.
- Before use, clean the battery from dust and check that the terminals are not oxydized or damaged.
- When the battery comes to an end never throw it in the garbage but deliver it to an authorized disposer.

3.10 WARNINGS ON THE ELECTRICAL SYSTEM

We are here listing the main warnings on the electrical system.

Please keep this in mind during the whole life of the engine.



WARNING:

If these prescriptions are not followed the electrical system and the engine could be damaged beyond repair. No obligation of IAME exists in this case.



- 1) Please turn the key to STOP position every time the engine is stopped. If the key is left in KEY position, for a long time, even if the engine is stopped, the battery would be discharged completely.
- 2) Never disconnect the ground cables with eyelets when the engine is in operation.
- 3) Disconnecting the battery when the engine is in operation DOES NOT increase the engine performance. Vice versa, the ignition advance could become very irregular at low RPM thus reducing the performance.
- 4) To fasten the eyelet terminal (groundings) of the wiring harness always use flat or open washers. Never use tab washers.
- 5) When disconnecting the connectors, always press the fixing tongues. Always pull the connectors to disconnect. NEVER PULL THE CABLES.
- 6) The electronic box and the starting relay must always be installed with their connector towards the bottom to avoid back water, dampness or dirt in the connector body.
- 7) Always correctly fix the H.T. coil with both screws, make sure that the laminations pack on H.T. coil is connected to the engine with the grounding cable. The eyelet connector must be directly in contact with the laminations pack on the H.T. coil.
- 8) Never use H.T. coils different than the original coil on the engine. Use of different coil may cause damages to the electronic box.
- 9) The digital assembly needs use of a resistive spark plug cap or spark plug. The resistor value must be equal or higher than 5 Kohm. Avoid use of resistive H.T. cables.
- 10) **The electrical system is protected against battery polarity reversal. When reversing the connectors on the battery, the protection circuit activates the fuse as soon as the key is on KEY or RUN position. The fuse must then be replaced.**
- 11) **Replace the fuse after having disconnected both terminals on the battery. Only use 5A strip fuse. Use of fuses with higher amperage might damage the electronic box whenever the battery polarity is reversed.**
- 12) Only use sealed lead type batteries as specified by IAME. Only use 12V. batteries.
- 13) Always disconnect the battery from the electrical system when recharging the battery with an external battery charger, otherwise the internal voltage regulator could be damaged.
- 14) DO NOT connect batteries in parallel; this might cause explosions and damages to the operator. The recharge of the battery, in normal conditions, is guaranteed by the electrical system. A few minutes of engine in operation are sufficient to recover the energy lost when starting the engine.
- 15) In case the battery must feed other users (Tachometer, Telemetry etc...), first contact IAME to check the recharge capacity of the system.
- 16) Modifications, interventions and additions to the original electric system might cause malfunctions. No obligation of IAME exists in this case.

3.11 SPARK PLUG AND THERMAL DEGREE

The engine is supplied with a standard **NGK BR10EG** spark plug, which represents a good compromise between the needs of a good running-in and the racing needs in normal conditions.

Use of different spark plugs is possible and, as a general information, we are attaching a correspondence list among spark plugs of other brands, based on **thermal degree** which represents the capacity of the spark plug to dissipate the internal heat. The colour of the various parts of the spark plug more exposed to the combustion flames gives a good indication on the adequacy of the thermal degree and on the carburation. It is necessary though to understand which of the two parameters has to be changed and only the experience tells how to identify the most proper thermal degree of a spark plug as lean or rich mixtures can generate the same final look which can also be achieved with a hot or cold spark plug.

See table:

<p>An excessive warm spark plug shows the symptoms, listed aside.</p>  <p>WARNING: <i>Always use a warmer than standard spark plug with cold or rainy climate.</i></p>	<ul style="list-style-type: none"> ▪ Extremely clear colour, porous look and calcification of the electrodes and of the internal insulation. ▪ Irregularities in the ignition, preignition and detonation with tendency to perforate the top of the piston. ▪ <i>Note: some of these symptoms can be achieved with lean mixtures.</i>
<p>A correct thermal degree shows:</p>	<ul style="list-style-type: none"> ▪ Colour of the insulator end from yellow grey to dark brown for mixtures respectively lean or rich.
<p>An excessively cold spark plug shows the symptoms, listed aside.</p>  <p>WARNING: <i>Always use a colder than standard spark plug with hot climates.</i></p>	<ul style="list-style-type: none"> ▪ Insulator end and electrodes covered with black shady soot. ▪ Ignition difficulties ▪ <i>Note: a wet or oily electrode could also mean an excessively rich mixture.</i>

COMPARISON TABLE BASED ON THE THERMAL DEGREE

HOT		
↑		
BOSCH	NGK	CHAMPION
WO8CS	BR9EG	N54R
WO7CS	BR10EG	N52R
WO6CS	BR11EG	
↓		
COLD		

3.12 CHOICE OF THE BEST SPROCKET RATIO

The life of an engine depends on many factors but most of all, upon the speed at which the engine is operated. If an engine is normally operated at speed higher than what recommended by the manufacturer, the wears and stress of the various components (con-rods, roller cages, bearings etc.) will be such as to drastically reduce the life of the engine itself. It is therefore extremely important that the user respects operating limits imposed by the manufacturer.

The operating limit for the "PARILLA X30" engine are respectively:

-14.000 Rpm

-15.500 Rpm

-16.000 Rpm

According to the different engine versions.



WARNING:

Never exceed the above limit. No obligation of IAME exists in case the above limit is exceeded.

In case the user wishes to optimize on the track the sprocket ratio in order to achieve the best possible performance, without abusing the engine, follow the under shown recommendations.

The engines are supplied with a 11 teeth sproket (pitch 7.775 mm.), but 10 and 12 teeth sprockets are available as accessories. Table 1 shows the various ratios between the sprocket on the axle and the engine sprocket given the different axle sprocket.

Tab.1

Sprocket ratio	Teeth n° - Engine sprocket			Sprocket ratio	Teeth n° - Engine sprocket		
Teeth n° Axle sprocket	10	11	12	Teeth n° Axle sprocket	10	11	12
72	7,20	6,55	6	83	8,30	7,55	6,92
73	7,30	6,64	6,08	84	8,40	7,64	7
74	7,40	6,73	6,17	85	8,50	7,73	7,08
75	7,50	6,82	6,25	86	8,60	7,82	7,17
76	7,60	6,91	6,33	87	8,70	7,91	7,25
77	7,70	7,00	6,42	88	8,80	8,00	7,33
78	7,80	7,09	6,5	89	8,90	8,09	7,42
79	7,90	7,18	6,58	90	9,00	8,18	7,5
80	8,00	7,27	6,67	91	9,10	8,27	7,58
81	8,10	7,36	6,75	92	9,20	8,36	7,67
82	8,20	7,45	6,83				

For the operation limit max. of 14.000, 15.500, 16.000 RPM the following table (Tab. 2a / 2b / 2c) has been prepared.

SUGGESTION:

- During the track tests we recommend use of a tachometer recording the max. obtained engine RPM.
- Use spark plug caps with a resistance of 5KΩ to avoid the eventual interferences between the engine ignition and the tachometer and/or telemetry.

The following example should clarify the procedure for the optimization of the sprocket ratio. Assume to use the engine with Z=10 teeth engine sprocket and that during the preliminary track tests a Z= 77 teeth axle sprocket has been used.

- From Table 1 with Z=10 as engine sprocket and Z= 77 on the axle sprocket, a ratio of 7.70 is found.
- Make a few laps on the track and record the maximum engine rpm achieved. Let us assume that you detect 13.600 RPM.
- From the Table 2a, to achieve a max RPM of 14.000 RPM (operating limit for the 1st engine X30 version) a sprocket ratio between 7.83 and 8.05 should be used (having used during the tests, a sprocket ratio of 7.7 and having achieved 13.600 RPM).
- From Table 1, with these values, a sprocket ratio of 10:78 / 10:80 should be used or, having a Z=11 on the engine sprocket, a ratio 11:87 should be used.

Sprocket ratio to achieve max 14000 RPM																	Tab. 2a	
Engine max RPM during tests	Sprocket ratio																	
	6,32	6,54	6,75	6,96	7,18	7,38	7,61	7,82	8,04	8,25	8,46	8,68	8,89	9,11	9,32	9,54	9,75	9,96
13000	6,81	7,04	7,27	7,50	7,73	7,95	8,20	8,42	8,66	8,88	9,11	9,35	9,57	9,81	10,04	10,27	10,50	10,73
13200	6,70	6,94	7,16	7,38	7,62	7,83	8,07	8,29	8,53	8,75	8,97	9,21	9,43	9,66	9,88	10,12	10,34	10,56
13400	6,60	6,83	7,05	7,27	7,50	7,71	7,95	8,17	8,40	8,62	8,84	9,07	9,29	9,52	9,74	9,97	10,19	10,41
13600	6,51	6,73	6,95	7,16	7,39	7,60	7,83	8,05	8,28	8,49	8,71	8,94	9,15	9,38	9,59	9,82	10,04	10,25
13800	6,41	6,63	6,85	7,06	7,28	7,49	7,72	7,93	8,16	8,37	8,58	8,81	9,02	9,24	9,46	9,68	9,89	10,10
14000	6,32	6,54	6,75	6,96	7,18	7,38	7,61	7,82	8,04	8,25	8,46	8,68	8,89	9,11	9,32	9,54	9,75	9,96
14200	6,23	6,45	6,65	6,86	7,08	7,28	7,50	7,71	7,93	8,13	8,34	8,56	8,76	8,98	9,19	9,41	9,61	9,82
14400	6,14	6,36	6,56	6,77	6,98	7,18	7,40	7,60	7,82	8,02	8,23	8,44	8,64	8,86	9,06	9,28	9,48	9,68
14600	6,06	6,27	6,47	6,67	6,88	7,08	7,30	7,50	7,71	7,91	8,11	8,32	8,52	8,74	8,94	9,15	9,35	9,55
14800	5,98	6,19	6,39	6,58	6,79	6,98	7,20	7,40	7,61	7,80	8,00	8,21	8,41	8,62	8,82	9,02	9,22	9,42
15000	5,90	6,10	6,30	6,50	6,70	6,89	7,10	7,30	7,50	7,70	7,90	8,10	8,30	8,50	8,70	8,90	9,10	9,30
15200	5,82	6,02	6,22	6,41	6,61	6,80	7,01	7,20	7,41	7,60	7,79	7,99	8,19	8,39	8,58	8,79	8,98	9,17
15400	5,75	5,95	6,14	6,33	6,53	6,71	6,92	7,11	7,31	7,50	7,69	7,89	8,08	8,28	8,47	8,67	8,86	9,05
15600	5,67	5,87	6,06	6,25	6,44	6,62	6,83	7,02	7,22	7,40	7,59	7,79	7,98	8,18	8,36	8,56	8,75	8,94
15800	5,60	5,79	5,98	6,17	6,36	6,54	6,74	6,93	7,12	7,31	7,50	7,69	7,88	8,07	8,26	8,45	8,64	8,83
16000	5,53	5,72	5,91	6,09	6,28	6,46	6,66	6,84	7,04	7,22	7,40	7,60	7,78	7,97	8,16	8,35	8,53	8,72
16200	5,46	5,65	5,83	6,01	6,20	6,38	6,58	6,76	6,95	7,13	7,31	7,50	7,68	7,87	8,05	8,24	8,43	8,61
16400	5,40	5,58	5,76	5,94	6,13	6,30	6,50	6,68	6,86	7,04	7,22	7,41	7,59	7,78	7,96	8,14	8,32	8,50
16600	5,33	5,52	5,69	5,87	6,06	6,22	6,42	6,60	6,78	6,96	7,13	7,32	7,50	7,68	7,86	8,05	8,22	8,40
16800	5,27	5,45	5,63	5,80	5,98	6,15	6,34	6,52	6,70	6,88	7,05	7,23	7,41	7,59	7,77	7,95	8,13	8,30
17000	5,20	5,39	5,56	5,73	5,91	6,08	6,27	6,44	6,62	6,79	6,97	7,15	7,32	7,50	7,68	7,86	8,03	8,20

Sprocket ratio to achieve max 15500 RPM																		Tab. 2b
Engine max RPM during tests	Sprocket ratio																	
	5,71	5,9	6,1	6,29	6,48	6,67	6,87	7,06	7,26	7,45	7,64	7,84	8,03	8,22	8,42	8,61	8,8	9
13000	6,81	7,03	7,27	7,50	7,73	7,95	8,19	8,42	8,66	8,88	9,11	9,35	9,57	9,80	10,04	10,27	10,49	10,73
13200	6,70	6,93	7,16	7,39	7,61	7,83	8,07	8,29	8,53	8,75	8,97	9,21	9,43	9,65	9,89	10,11	10,33	10,57
13400	6,60	6,82	7,06	7,28	7,50	7,72	7,95	8,17	8,40	8,62	8,84	9,07	9,29	9,51	9,74	9,96	10,18	10,41
13600	6,51	6,72	6,95	7,17	7,39	7,60	7,83	8,05	8,27	8,49	8,71	8,94	9,15	9,37	9,60	9,81	10,03	10,26
13800	6,41	6,63	6,85	7,06	7,28	7,49	7,72	7,93	8,15	8,37	8,58	8,81	9,02	9,23	9,46	9,67	9,88	10,11
14000	6,32	6,53	6,75	6,96	7,17	7,38	7,61	7,82	8,04	8,25	8,46	8,68	8,89	9,10	9,32	9,53	9,74	9,96
14200	6,23	6,44	6,66	6,87	7,07	7,28	7,50	7,71	7,92	8,13	8,34	8,56	8,77	8,97	9,19	9,40	9,61	9,82
14400	6,15	6,35	6,57	6,77	6,98	7,18	7,39	7,60	7,81	8,02	8,22	8,44	8,64	8,85	9,06	9,27	9,47	9,69
14600	6,06	6,26	6,48	6,68	6,88	7,08	7,29	7,50	7,71	7,91	8,11	8,32	8,53	8,73	8,94	9,14	9,34	9,55
14800	5,98	6,18	6,39	6,59	6,79	6,99	7,19	7,39	7,60	7,80	8,00	8,21	8,41	8,61	8,82	9,02	9,22	9,43
15000	5,90	6,10	6,30	6,50	6,70	6,89	7,10	7,30	7,50	7,70	7,89	8,10	8,30	8,49	8,70	8,90	9,09	9,30
15200	5,82	6,02	6,22	6,41	6,61	6,80	7,01	7,20	7,40	7,60	7,79	7,99	8,19	8,38	8,59	8,78	8,97	9,18
15400	5,75	5,94	6,14	6,33	6,52	6,71	6,91	7,11	7,31	7,50	7,69	7,89	8,08	8,27	8,47	8,67	8,86	9,06
15500	5,71	5,90	6,10	6,29	6,48	6,67	6,87	7,06	7,26	7,45	7,64	7,84	8,03	8,22	8,42	8,61	8,80	9,00
15600	5,67	5,86	6,06	6,25	6,44	6,63	6,83	7,01	7,21	7,40	7,59	7,79	7,98	8,17	8,37	8,55	8,74	8,94
15800	5,60	5,79	5,98	6,17	6,36	6,54	6,74	6,93	7,12	7,31	7,49	7,69	7,88	8,06	8,26	8,45	8,63	8,83
16000	5,53	5,72	5,91	6,09	6,28	6,46	6,66	6,84	7,03	7,22	7,40	7,60	7,78	7,96	8,16	8,34	8,53	8,72
16200	5,46	5,65	5,84	6,02	6,20	6,38	6,57	6,75	6,95	7,13	7,31	7,50	7,68	7,86	8,06	8,24	8,42	8,61
16400	5,40	5,58	5,77	5,94	6,12	6,30	6,49	6,67	6,86	7,04	7,22	7,41	7,59	7,77	7,96	8,14	8,32	8,51
16600	5,33	5,51	5,70	5,87	6,05	6,23	6,41	6,59	6,78	6,96	7,13	7,32	7,50	7,68	7,86	8,04	8,22	8,40
16800	5,27	5,44	5,63	5,80	5,98	6,15	6,34	6,51	6,70	6,87	7,05	7,23	7,41	7,58	7,77	7,94	8,12	8,30
17000	5,21	5,38	5,56	5,74	5,91	6,08	6,26	6,44	6,62	6,79	6,97	7,15	7,32	7,49	7,68	7,85	8,02	8,21

Sprocket ratio to achieve max 16000 RPM																		Tab. 2c
Engine max RPM during tests	Sprocket ratio																	
	5,53	5,72	5,91	6,09	6,28	6,47	6,66	6,84	7,03	7,22	7,41	7,59	7,78	7,97	8,16	8,34	8,53	8,72
13000	6,81	7,04	7,27	7,50	7,73	7,96	8,20	8,42	8,65	8,89	9,12	9,34	9,58	9,81	10,04	10,26	10,50	10,73
13200	6,70	6,93	7,16	7,38	7,61	7,84	8,07	8,29	8,52	8,75	8,98	9,20	9,43	9,66	9,89	10,11	10,34	10,57
13400	6,60	6,83	7,06	7,27	7,50	7,73	7,95	8,17	8,39	8,62	8,85	9,06	9,29	9,52	9,74	9,96	10,19	10,41
13600	6,51	6,73	6,95	7,16	7,39	7,61	7,84	8,05	8,27	8,49	8,72	8,93	9,15	9,38	9,60	9,81	10,04	10,26
13800	6,41	6,63	6,85	7,06	7,28	7,50	7,72	7,93	8,15	8,37	8,59	8,80	9,02	9,24	9,46	9,67	9,89	10,11
14000	6,32	6,54	6,75	6,96	7,18	7,39	7,61	7,82	8,03	8,25	8,47	8,67	8,89	9,11	9,33	9,53	9,75	9,97
14200	6,23	6,45	6,66	6,86	7,08	7,29	7,50	7,71	7,92	8,14	8,35	8,55	8,77	8,98	9,19	9,40	9,61	9,83
14400	6,14	6,36	6,57	6,77	6,98	7,19	7,40	7,60	7,81	8,02	8,23	8,43	8,64	8,86	9,07	9,27	9,48	9,69
14600	6,06	6,27	6,48	6,67	6,88	7,09	7,30	7,50	7,70	7,91	8,12	8,32	8,53	8,73	8,94	9,14	9,35	9,56
14800	5,98	6,18	6,39	6,58	6,79	6,99	7,20	7,39	7,60	7,81	8,01	8,21	8,41	8,62	8,82	9,02	9,22	9,43
15000	5,90	6,10	6,30	6,50	6,70	6,90	7,10	7,30	7,50	7,70	7,90	8,10	8,30	8,50	8,70	8,90	9,10	9,30
15200	5,82	6,02	6,22	6,41	6,61	6,81	7,01	7,20	7,40	7,60	7,80	7,99	8,19	8,39	8,59	8,78	8,98	9,18
15400	5,75	5,94	6,14	6,33	6,52	6,72	6,92	7,11	7,30	7,50	7,70	7,89	8,08	8,28	8,48	8,66	8,86	9,06
15500	5,71	5,90	6,10	6,29	6,48	6,68	6,87	7,06	7,26	7,45	7,65	7,83	8,03	8,23	8,42	8,61	8,81	9,00
15600	5,67	5,87	6,06	6,25	6,44	6,64	6,83	7,02	7,21	7,41	7,60	7,78	7,98	8,17	8,37	8,55	8,75	8,94
15800	5,60	5,79	5,98	6,17	6,36	6,55	6,74	6,93	7,12	7,31	7,50	7,69	7,88	8,07	8,26	8,45	8,64	8,83
16000	5,53	5,72	5,91	6,09	6,28	6,47	6,66	6,84	7,03	7,22	7,41	7,59	7,78	7,97	8,16	8,34	8,53	8,72
16200	5,46	5,65	5,84	6,01	6,20	6,39	6,58	6,76	6,94	7,13	7,32	7,50	7,68	7,87	8,06	8,24	8,42	8,61
16400	5,40	5,58	5,77	5,94	6,13	6,31	6,50	6,67	6,86	7,04	7,23	7,40	7,59	7,78	7,96	8,14	8,32	8,51
16600	5,33	5,51	5,70	5,87	6,05	6,24	6,42	6,59	6,78	6,96	7,14	7,32	7,50	7,68	7,87	8,04	8,22	8,40
16800	5,27	5,45	5,63	5,80	5,98	6,16	6,34	6,51	6,70	6,88	7,06	7,23	7,41	7,59	7,77	7,94	8,12	8,30
17000	5,20	5,38	5,56	5,73	5,91	6,09	6,27	6,44	6,62	6,80	6,97	7,14	7,32	7,50	7,68	7,85	8,03	8,21

4.1 CENTRIFUGAL CLUTCH

The engine has a low maintenance dry centrifugal clutch. The following prescriptions, if carefully followed, will allow a clutch longlife.

When starting the engine, make sure that the brake pedal is fully pressed to avoid sudden accelerations.



WARNING:

Once the engine is started, avoid useless accelerations which can overheat and deteriorate the clutch. Oil the chain before each session. Immediately after each race or test, check the engine sprocket . Replace if necessary.

A bad alignment of the engine sprocket with the axle sprocket or the lack of oil will damage irreparably the sprocket.

Check the clutch:

- every 5 hours of use.
- When metallic noises are heard inside the clutch.
- If the kart dragging speed exceeds 6000 RPM.
- Every time the clutch has overheated (presence of smoke or smell of burning).

To check the clutch, you must remove the clutch cover and the clutch drum.

Replace the clutch:

- whenever the thickness of the friction material (see drawing) is lower than 1.5mm on point A of the clutch or if the body diameter is lower than 83mm.
- Whenever the external friction material in the A portion of the clutch is very rough (wear or degradation of the friction material due to overheating).



WARNING:

In case the friction material has been totally worn out and there has been a metal contact between the clutch body and the clutch drum, it is necessary to replace the clutch drum. See drawing.

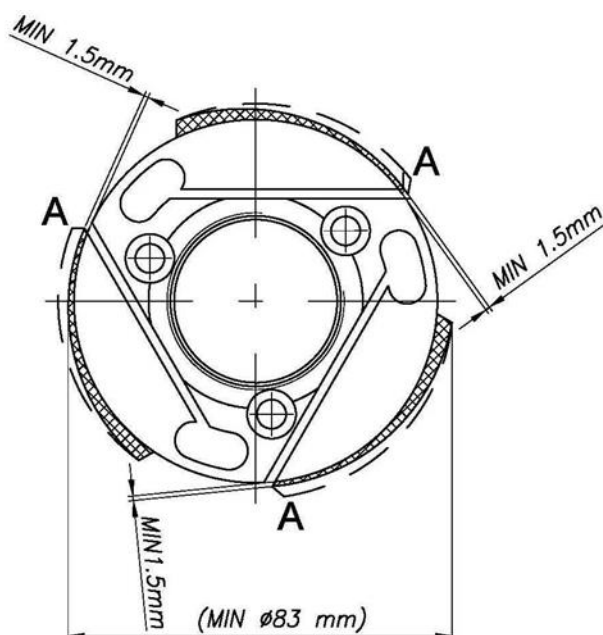

4.2 INSTRUCTIONS FOR THE DISASSEMBLY/ASSEMBLY OF THE CLUTCH



WARNING:

the following operations can be performed by a skilled mechanic, under the conditions to have available the dedicated tools shown in the text, otherwise it is necessary to apply to an Authorized Service Center.

Refer to the following drawing during the operations.

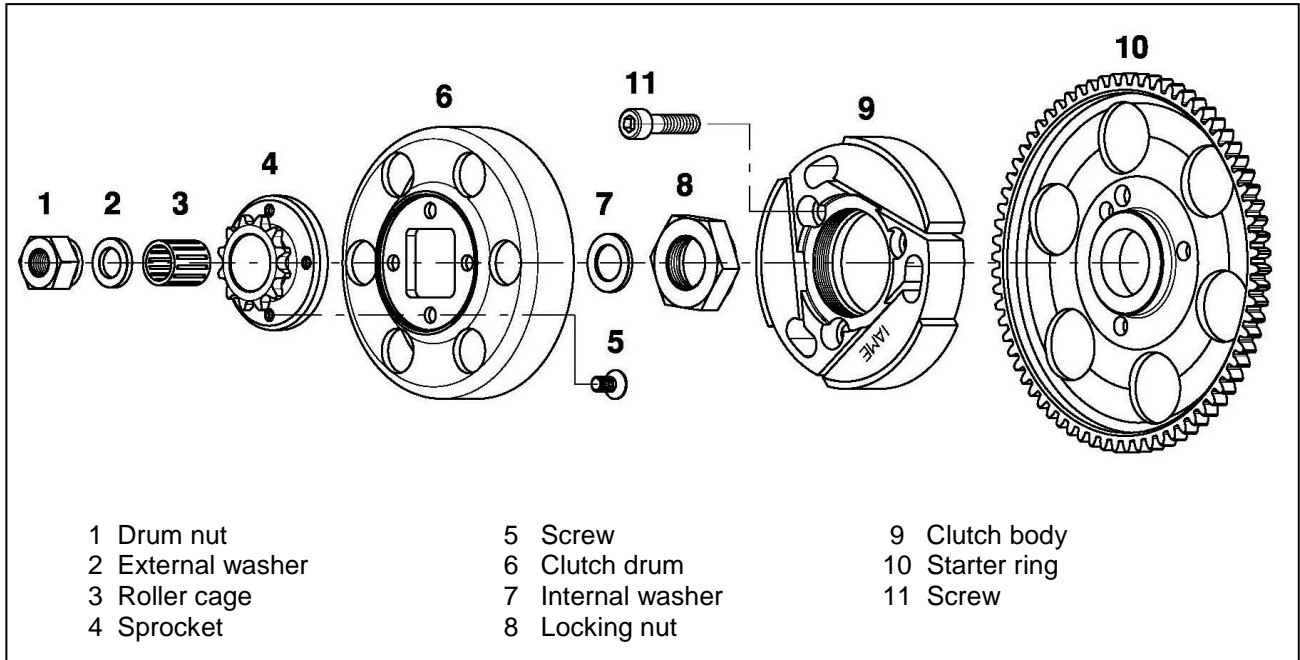

<u>OPERATIONS</u>	<u>TOOLS</u>
<u>Clutch disassembly</u>	
1. Remove the clutch cover (3 screws M6).	<ul style="list-style-type: none"> ▪ Allen wrench 5mm – T type
2. Remove the Bendix support and replace it with starter wheel locking tool.	<ul style="list-style-type: none"> ▪ Starter wheel locking tool: P.N. S884
3. Remove nut (1 nut M10).	<ul style="list-style-type: none"> ▪ 12 point wrench 17 mm
4. Remove the external washer, the drum complete with roller cage, the internal washer.	
5. Remove the special tool from the head and using the clutch wrench remove the M20x1 nut and the starter wheel.	<ul style="list-style-type: none"> ▪ Starter wheel locking tool: P.N. S884 ▪ 30mm socket.
WARNING: turn clockwise as the nut has left thread	
6. Apply the clutch puller on clutch hub and remove the clutch hub with the starter wheel.	<ul style="list-style-type: none"> ▪ Clutch puller: P.N. ATT-026 ▪ 12 point wrench 12mm.
7. Remove the starter wheel (3 screws M6)	<ul style="list-style-type: none"> ▪ 12 point wrench 5mm

Before assembling the clutch, wash with diluent the shaft taper, the connecting hole on the clutch body, the clutch drum and the starter wheel.

<u>Install clutch</u>	
1. Install the starter wheel on the clutch hub by matching the three holes and the dragging pin (3 screws M6). ⚠ ATTENTION: make sure to always install the $\varnothing 7$ mm dragging pin as otherwise, the eventual kick backs, could break the screws.	<ul style="list-style-type: none"> ▪ 12 point wrench 10 mm (torque at 10 Nm) (90 in-lb) (apply "Loctite" on the threads)
2. Install clutch body and the cone safety washer.	Apply "Loctite 641" for coaxial lockings
3. Install the clutch body fixing nut and starter wheel, using the 30mm clutch wrench. ⚠ ATTENTION: turn counterclockwise as nut has left thread.	<ul style="list-style-type: none"> ▪ Starter wheel locking tool: S 884 ▪ 12 point wrench 30 mm. (torque at 100 ÷ 110 Nm) (885 ÷ 970 in-lb)
4. Install the internal washer. ⚠ ATTENTION: install washer with bevel towards internal part of the engine. Clean the roller cage and grease it before installing it on the crankshaft.	
5. Install the clutch drum and the external washer. ⚠ ATTENTION: install washer with bevel towards internal part of the engine.	
6. Install the starter wheel locking ool to prevent the shaft from turning and install the clutch cover (M10 nut) .	<ul style="list-style-type: none"> ▪ Starter wheel locking tool: S 884 ▪ 17 mm socket (torque at 30 ÷ 40 Nm) (265 ÷ 350 in-lb)
7. Install the clutch cover (3 screws M 6).	<ul style="list-style-type: none"> ▪ Allen wrench 5 mm – T type. (torque at 8 ÷ 10 Nm) (70 ÷ 90 in-lb)



4.3 GEAR TIMING SCHEMATIC

In case of assembly of the gears which drive the balance shaft, assembly must be performed following the timing schematic shown below.

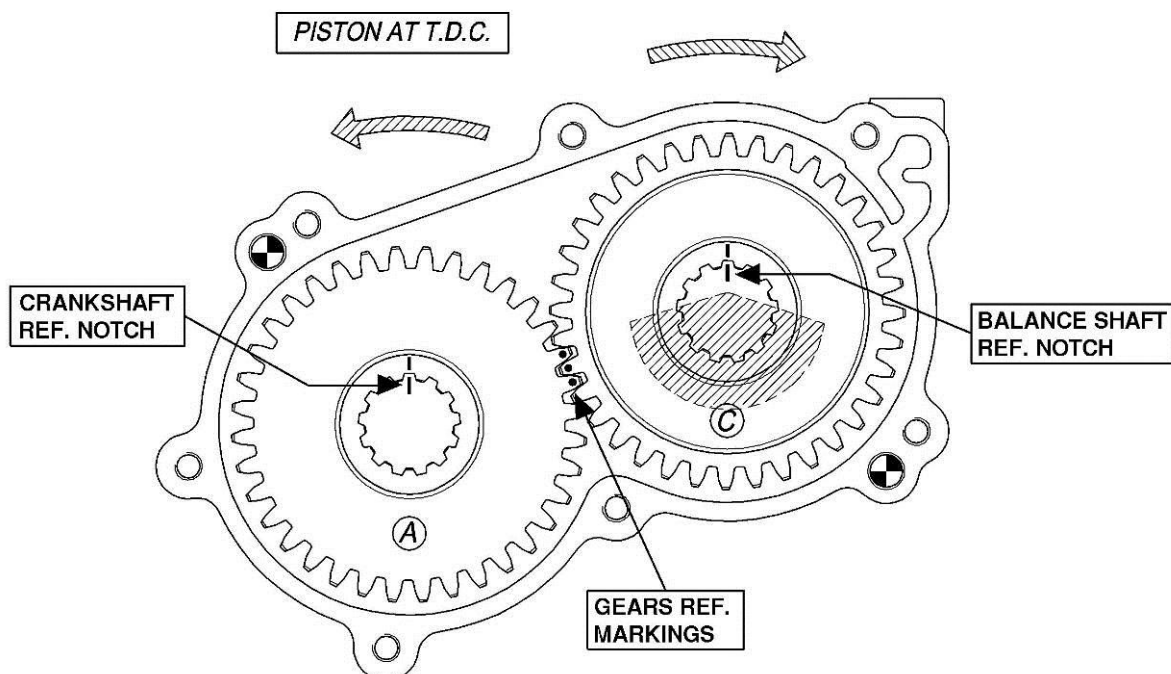
⚠ ATTENTION:
An incorrect assembly of the gears can cause a malfunction in the vibration reduction system.

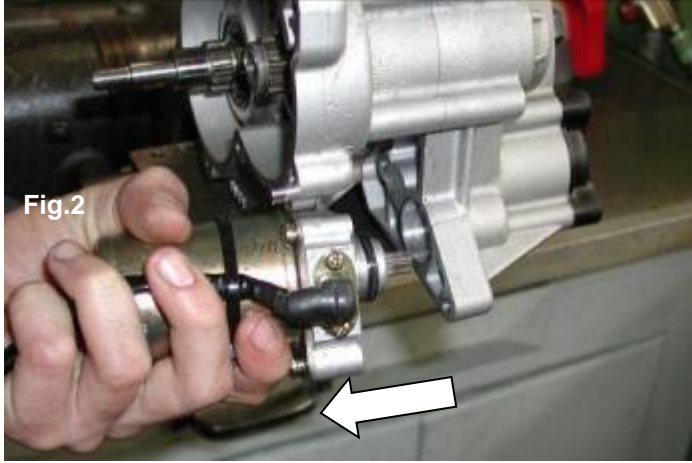
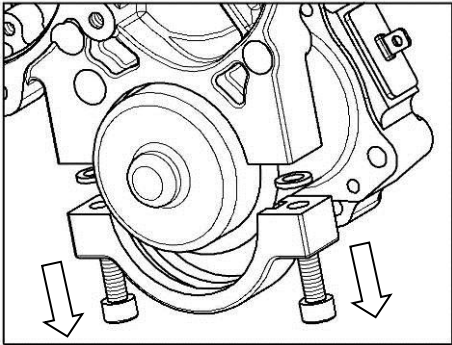

4.4 REPLACEMENT OF THE STARTER BRUSHES

	<u>OPERATIONS</u>	<u>PICTURES</u>
	<p>1. <u>DISASSEMBLE THE STARTER</u></p> <p>- UNSCREW N°2 SCREWS M6x35 (see Fig.1).  (5mm ALLEN WRENCH – T TYPE)</p> <p>- REMOVE STARTER (see Fig.2).</p> <p><u>NOTE:</u> <u>ON THE ENGINES MANUFACTURED AFTER SEPTEMBER '05, THE STARTER CAN BE REMOVED WITHOUT TAKING AWAY THE GEARS COVER BUT SIMPLY BY REMOVING THE COVER CLAMP (see drawing)</u></p>	  <p>Fig.2</p> 

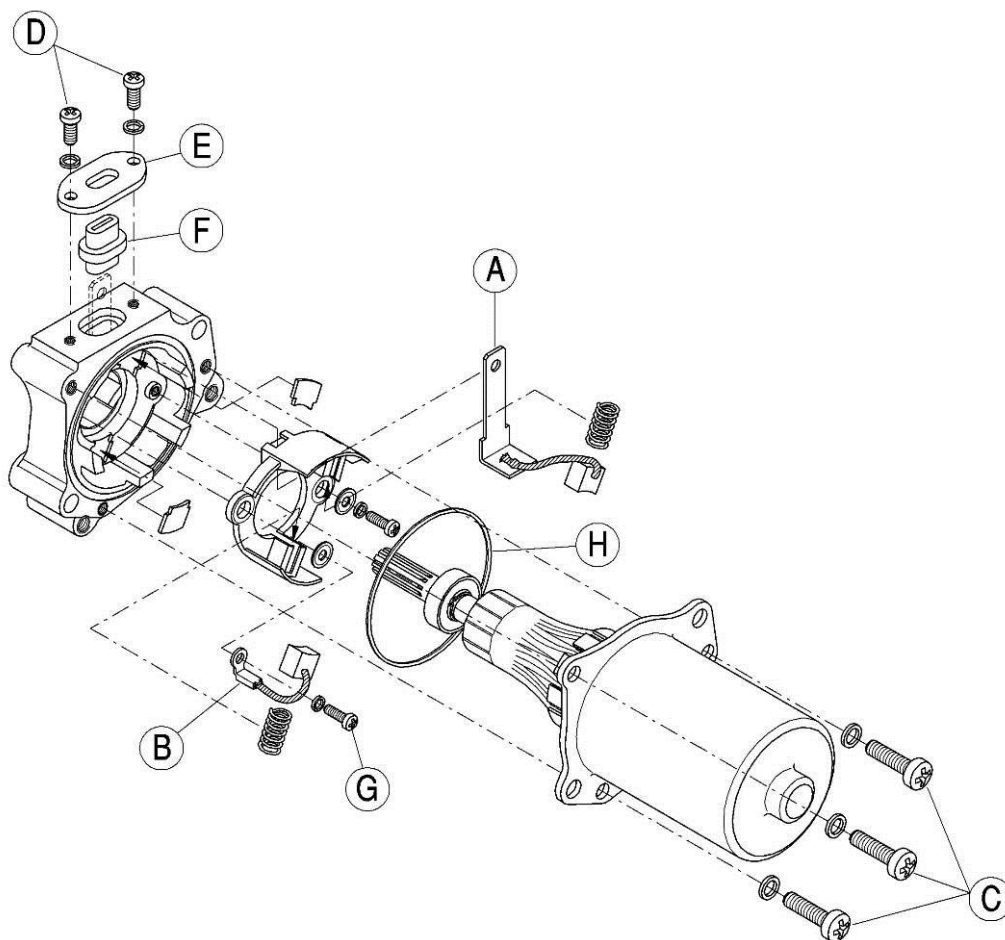

2. OPENING THE STARTER

-REMOVE THE PLASTIC CLAMP AND UNSCREW THE SCREW M4 FIXING THE INPUT CABLE TO THE STARTER

(see Fig.3)



(PHILLIPS SCREWDRIVER)

- UNSCREW 3 SCREWS M5 "C"

(see Fig.4)



(PHILLIPS SCREWDRIVER)

Fig.3



Fig.4



- REMOVE DRUM FROM STARTER
KEEPING ROTOR IN ITS SEAT
(BE SURE TO HOLD THE ROTOR ON ITS
TOOTHED SIDE TO PREVENT BRUSHES FROM
FALLING OUT FROM THEIR SEAT)
(see Fig.5)

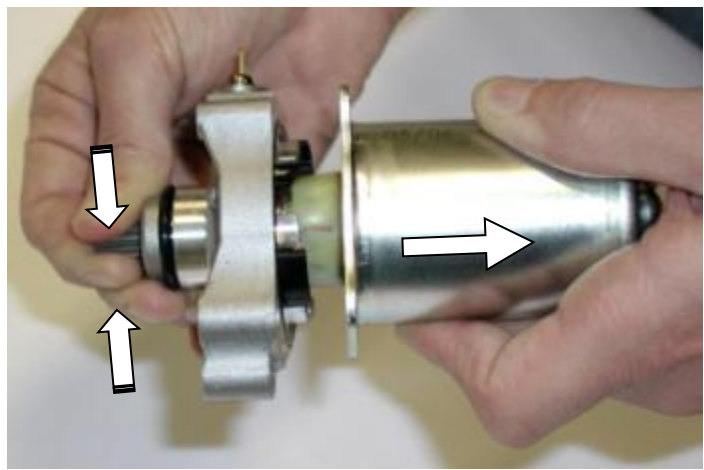



Fig.5

- REMOVE ROTOR FROM STARTER HEAD
(see Fig.6)

 **ATTENTION:**
WHEN EXTRACTING ROTOR, THE BRUSHES
MAY SPRING OUT FROM THEIR SEATS.

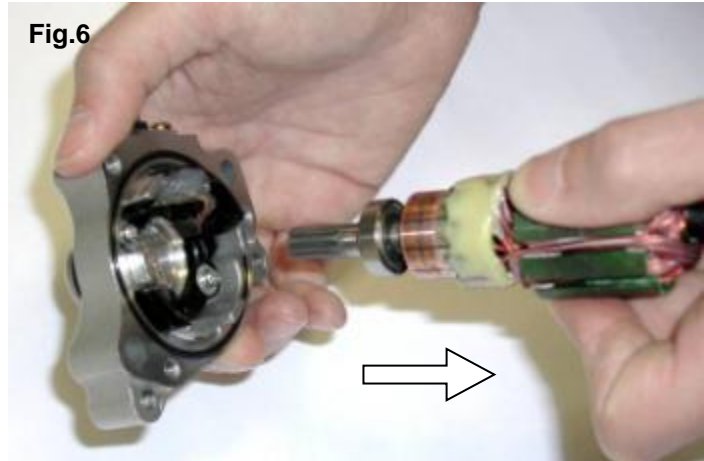

Fig.6

3.

REPLACING THE BRUSH "A"

- UNSCREW THE 2 SCREWS M4 "D"
RETAINING THE PLATE "E"

(see Fig.7).



(PHILLIPS SCREWDRIVER)



Fig.7

- REMOVE THE LITTLE RUBBER CAP "F"

(see Fig.8).



(PLIERS)

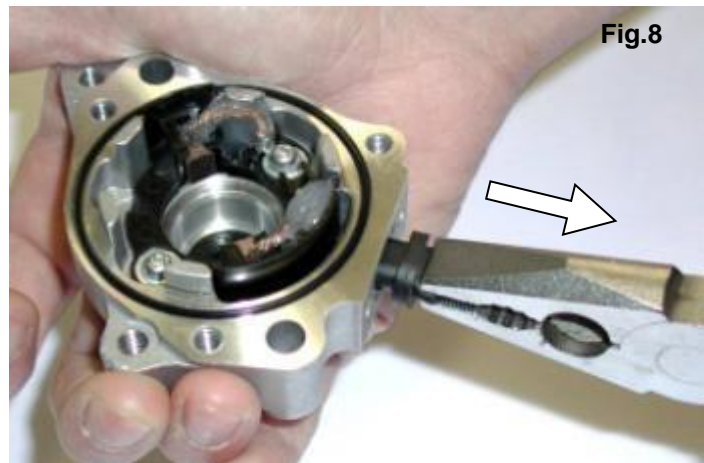

Fig.8

OUR SUGGESTION:
SLIGHTLY OIL THE TIN PLATE TERMINAL END,
TO MAKE EASIER THE EXTRACTION OF THE
LITTLE RUBBER CAP.

- REMOVE SILICONE FROM BRUSHES WITH A SCREWDRIVER

(see Fig.9).

- REMOVE SPRINGS

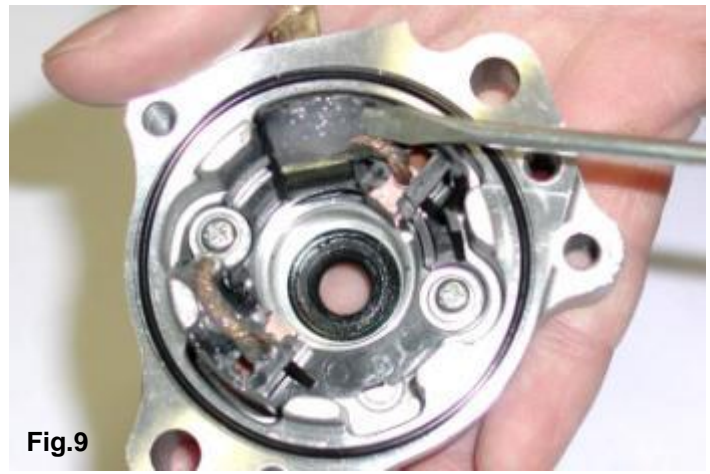

Fig.9

- MAKING PRESSURE EXTERNALLY ON THE TIN PLATE TERMINAL, REMOVE BRUSH.

(see Fig.10).

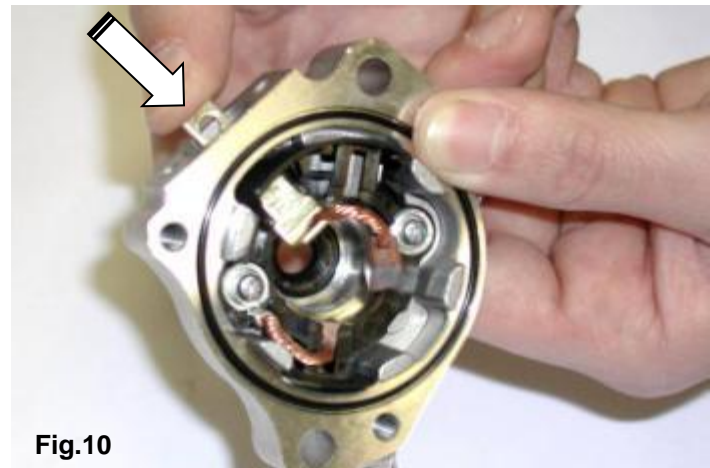

Fig.10

- INSTALL NEW BRUSH TERMINAL INSIDE

(see Fig.11).

- PLACE LITTLE RUBBER CAP ON THE TERMINAL

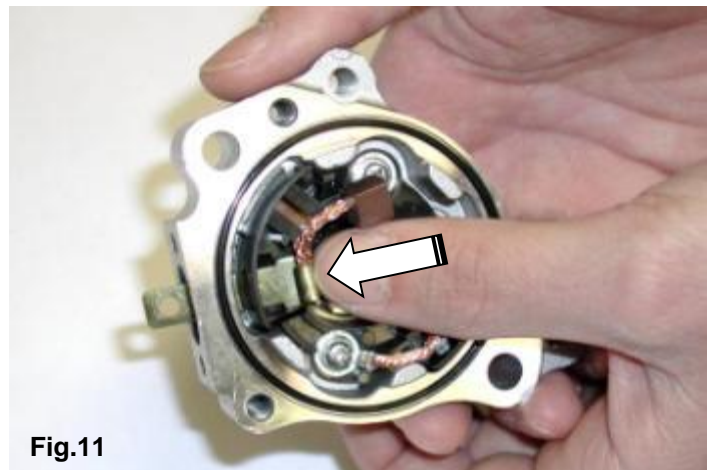

Fig.11

- REINSTALL THE PLATE AND FIXE IT WITH THE 2 SCREWS M4

(see Fig.12).

(PHILLIPS SCREWDRIVER)



Fig.12





4. **REPLACEMENT OF THE BRUSH "B"**

- UNLOOSE THE SCREW M3 "G"

(see Fig.13)

- EXTRACT THE BRUSH

- FIX THE NEW BRUSH WITH SCREW M3

(PHILLIPS SCREWDRIVER)



Fig.13

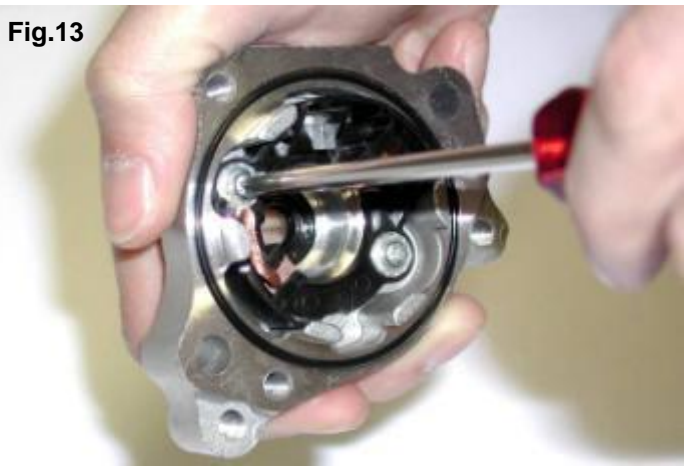

5. **CLOSING THE STARTER**

- INSERT THE NEW BRUSH SPRING "A" INTO ITS SEAT.

- INSTALL THE BRUSH .

- KEEP THE BRUSH IN PLACE BY PRESSING TOWARDS THE OUTER AND CLAMP IT WITH AN IRON WIRE BENT AS A HOOK.

REPEAT THE SAME PROCEDURE TO INSTALL THE BRUSH "B"

(see Fig. 14).



Fig.14



- INSTALL THE STARTER ROTOR BETWEEN THE BRUSHES AND CHECK, THAT THEY ARE ALWAYS IN CONTACT WITH THE CYLINDRIC COPPER PART OF THE ROTOR, EVEN WHEN THEY ARE RELEASED

(see Fig. 15).

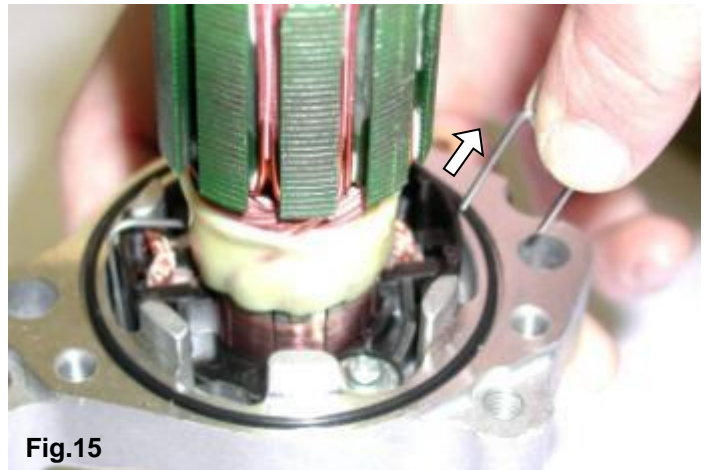
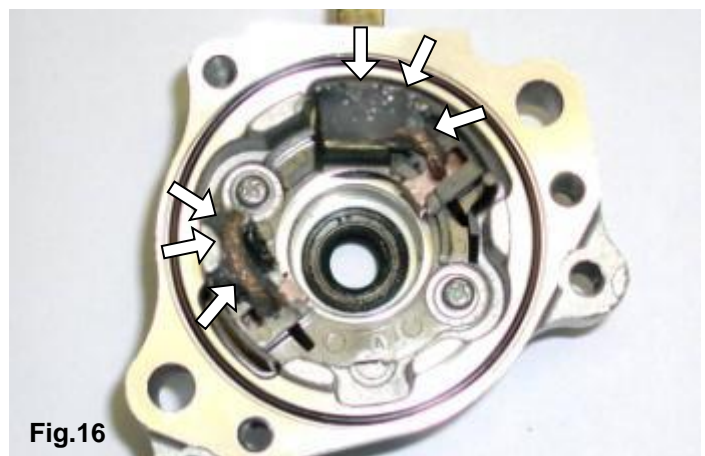

Fig.15

**OUR SUGGESTION:
TO IMPROVE THE BRUSHES LIFE, SECURE THE
LITTLE WIRES WITH SILICONE**

(see Fig. 16).

Fig.16



- CHECK THAT O-RING "H" IS INSTALLED ON THE STARTER HEAD.

- INSERT STARTER DRUM ON THE HEAD BEING CAREFUL TO PREVENT ROTOR FROM ROTATING AND TO PREVENT THE BRUSHES FROM FALLING OUT OF THEIR SEAT

(see Fig. 17).

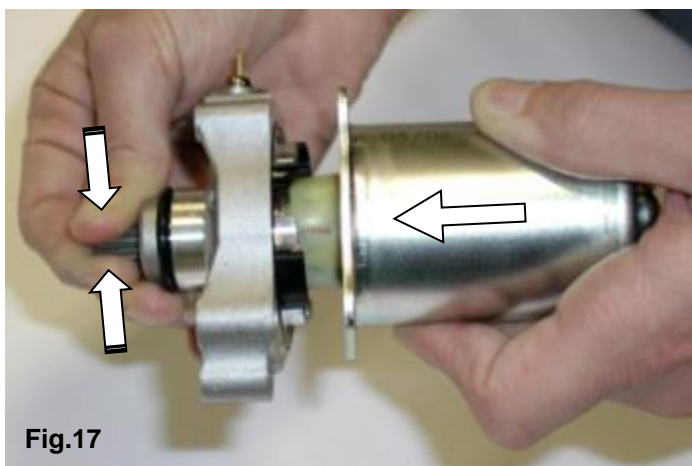

- SCREW THE 3 SCREWS M5

(see Fig. 18).

(PHILLIPS SCREWDRIVER)



- CHECK THAT THE STARTER ROTOR ROTATES FREELY.



- CONNECT THE INPUT WIRING TO THE STARTER WITH THE SCREW M4

(see Fig. 19).

(PHILLIPS SCREWDRIVER)



- SECURE THE WIRE TO THE STARTER BY MEANS OF A PLASTIC CLAMP (see Fig.20).



6. ASSEMBLING THE STARTER

- PLACE THE STARTER INTO THE CRANKCASE

(see Fig.20).

OIL O-RING TO MAKE EASIER INSTALLATION.

N°2 SCREWS TCH M6x35
TIGHTEN AT A 8÷10 Nm (70÷90 in-lb)

(5mm WRENCH – T TYPE)



4.5 SCHEDULED MAINTENANCE

Following some simple maintenance standards will allow the engine to perform more reliably and have a longer life.

SCHEDULE	COMPONENTS	ACTIONS AND COMMENTS
Before using	Exhaust flexible	Check status
	Exhaust spring	Check status
	Insulating sleeve	Check status
	Silencer	Check status and fixing
	Engine sprocket	Check wear Check alignment with axle sprocket
	Engine chain	Check wear, tensioning and oil chain
	Battery	Check status and charge
	Cables and connectors	Check status and connectors
	Grounding of engine and electronic box	Check status and connectors
	Engine mounts and clamps	Check torques
	Battery support and clamps	Check torques
After use	Battery	Disconnect
	Chain	Check status and oil chain
	Engine	External cleaning
Every 5 ÷ 10 hours	Bendix assembly	Remove cover (see fig.) and clean internally
		
	Exhaust muffler	Remove muffler end, clean
	Inlet silencer	Open, clean
	Engine head	Open, clean
	Clutch	Open, check status of parts
Every 20 hours	Piston and con-rod assembly	Check and replace worn parts
	Crankshaft	Check and replace worn parts
	Bearings / balance shaft	Check and replace worn parts
	Gears	Check and replace worn parts
	Balance shaft	Check and replace worn parts

4.6 TROUBLESHOOTING

Below are some common faults, their probable causes and suggested remedy.

<u>FAULTS</u>	<u>PROBABLE CAUSES</u>	<u>REMEDY</u>
Starter will not crank when turning the key to RUN position	Bad connections on starter cables	Check and tighten
	Bad grounding	Check connections and tighten
	Interruption on fuse	Replace 5A strip fuse, after checking for eventual reversal of battery polarity.
	Damaged cables	Replace
	Battery connection loose	Check and tighten
	Battery discharged	Recharge or replace battery
	Starter failure	Overhaul starter
Starter cranks but engine won't start when turning the key in RUN position	Electronic box or relay failure	Apply to Authorized Service Centers
	Bad cable connections	Check connectors
	Bad H.T. coil connections or coil failure	Check/replace
	Bad H.T. coil grounding	Check grounding
	Electronic box or ignition failure	Apply to Authorized Service Centers
	Wet spark plug	Replace
Engine starts but it stops after a few seconds when turning the key in RUN position	Malfuction on induction system	Check status and connection on fuel pipe Replace gaskets and membranes on carburetor Check reed petals. Replace if necessary.
	Bad cable connections	Check stator connector
	Electronic box or starter failure	Apply to Authorized Service Centers
The starter cranks also after the engine is running.	Bad carburetor adjustment (screw I)	Check carburetor adjustment (see sect. 3.3)
	Bad carb. adjustment (screw I)	Check carburetor adjustment (see sect. 3.3)
Rough idle	Bad carb. adjustment (screw I)	Check carburetor adjustment (see sect. 3.3)
Drop in engine performance	Electronic box failure	Apply to Authorized Service Centers
	Bad compression	Check piston
	Bad carburetor adjustment	Check carburetor adjustment (see sect. 3.3)
	Insufficient fuel flow	Check fuel flow lines and inlet filter
Burning smell, smoke	Dirty inlet silencer	Check and clean
	Clutch overheating	Check clutch (see sect. 4.1)
Clutch engages at too high RPM	Excessive wear of friction material	Check clutch (see sect. 4.1)
Exhaust too noisy	Damaged flexible	Check and replace if necessary
	Springs damaged or lost	
	Damaged insulating sleeve	
	Damaged exhaust header	

4.7 ENGINE PRESERVATION

When engine is to remain unoperative for a long period it must be preserved as follow:

- Disconnect the battery and charge it periodically (see sect. 3.9).
- Disconnect carburetor and clean it.
- Seal with tape the engine inlet and exhaust.

The external of the engine must be cleaned. Spray with protective oil, the steel parts subject to oxidation. Keep the engine in a dry ambient.

In the event of a long unoperative period of the engine, release the hose fixed between the water pump inlet and the radiator outlet (as shown in the picture) and empty the water circuit to avoid damages to the engine and the accessories due to freezing.

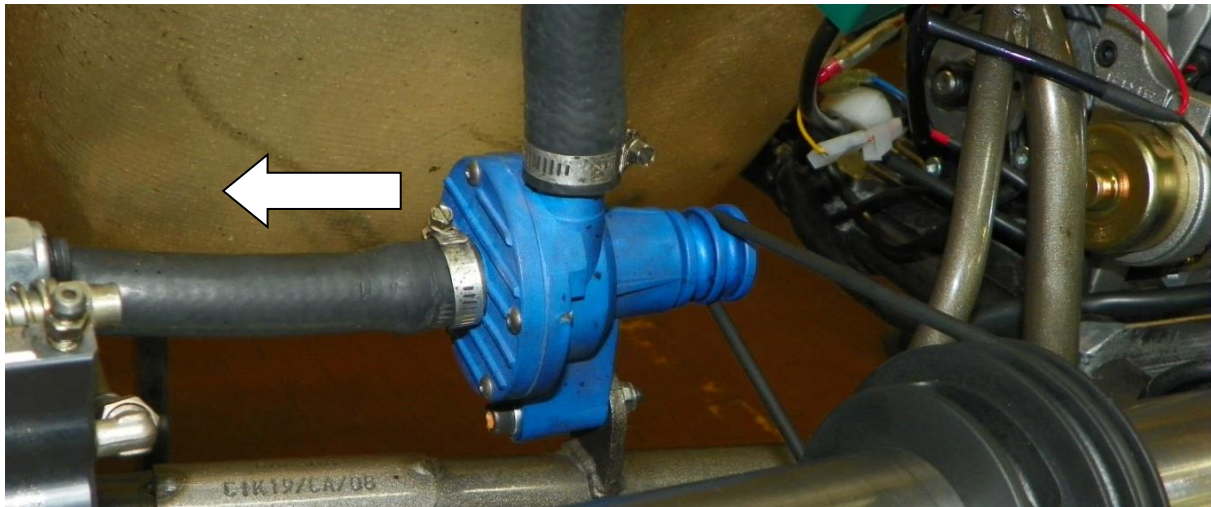

4.8 TORQUE VALUES

NOMINAL SIZE	Q.TY	FASTENER NAME	WRENCH	VALUES(Nm)	VALUES(in·lb)
M14 x 1.25	1	Spark plug	Hex.20.8	20 – 26	175 – 230
M8 x 1.25	4	Head and cylinder nut	Hex. 13	18 – 22	160 – 190
M8 x 1.25	2	Exhaust nut	Hex. 13	18 – 22	160 – 190
M6 x 1	4	Reed group screw	Allen 5	8 – 10	70 – 90
M6 x 1	2	Carb. fixing stud-bolt	Allen 5	6 – 10	50 – 90
M5 x 0.8	4	Ign.Digit."K"stator fixing screw	Allen 4	5 – 6	45 – 50
M10 x 1	1	Ign.Digit."K" rotor fixing nut	Hex. 17	20 – 26	175 – 230
M6 x 1	3	"Bendix" support screw	Allen 5	6 – 8	50 – 70
M6 x 1	2	Starter fixing screw	Allen 5	8 – 10	70 – 90
M6 x 1	3	Clutch cover fixing screw	Allen 5	8 – 10	70 – 90
M10 x 1	1	Clutch drum holding nut	Hex. 17	30 – 40	265 – 350
M20 x 1	1	Starter ring fixing nut	Hex. 30	100–110	885 – 970
M5 x 0.8	4	Engine sprocket fixing screw	Allen 3	6 – 8	50 – 70
M6 x 1	3	Clutch fixing screw	Hex. 10	9 – 11	80 – 100
M6 x 1	10	Crankcase fixing screw	Allen 5	8 – 10	70 – 90
M6 x 1	7	Gears cover fixing screw	Allen 5	8 – 10	70 – 90
M5 x 0.8	1	Bal. shaft bearing fix. screw	Allen 3	6 – 8	50 – 70
M6 x 1	2	Coil fixing nut	Hex. 10	8 – 10	70 – 90
M6 x 1	2	Coil/starter ground. fix. screw	Allen 5	8 – 10	70 – 90
M10 x 1	2	Oil charge/discharge plug	Hex. 17	12 – 15	105 – 130

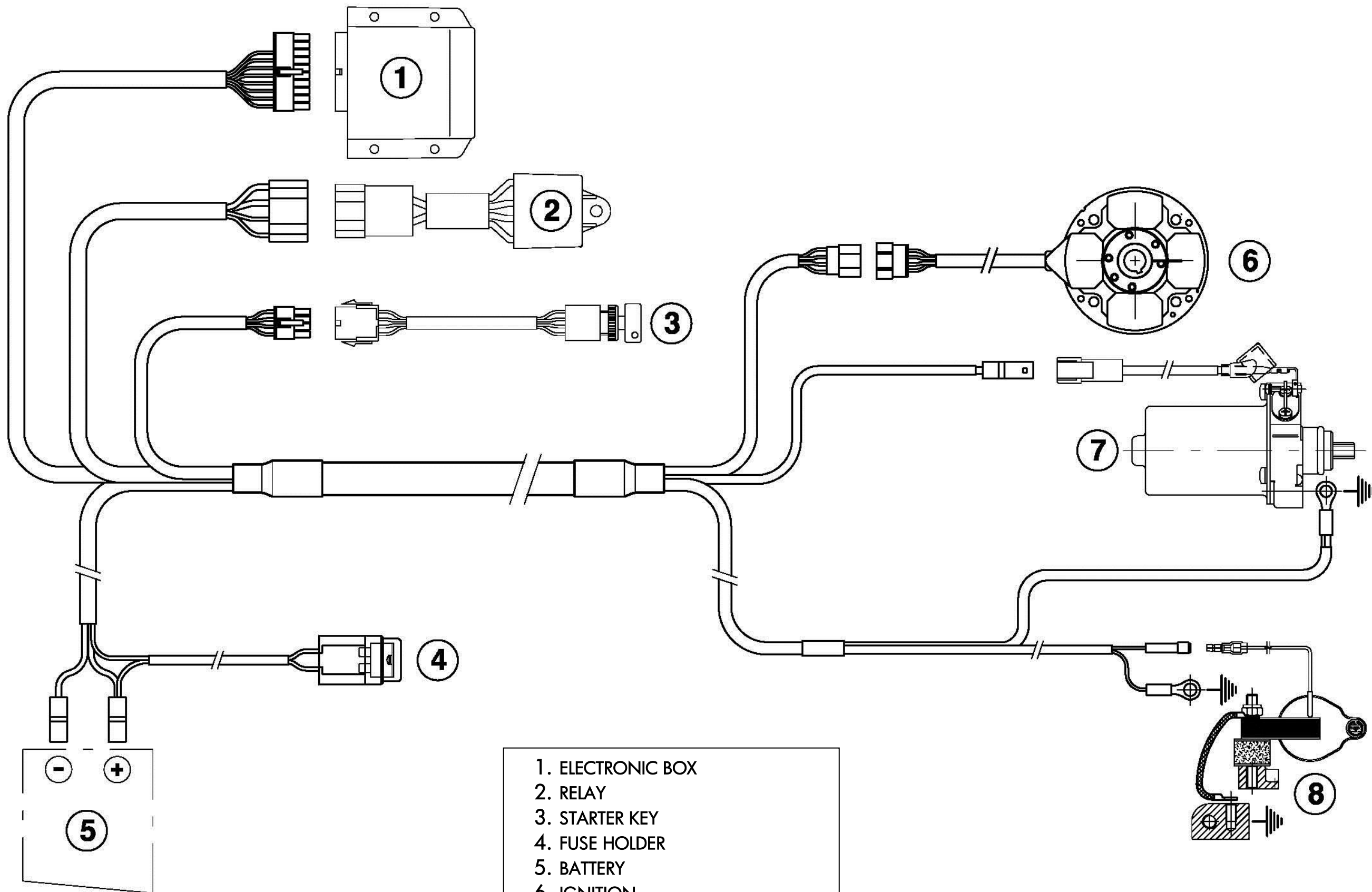

- 1. ELECTRONIC BOX
- 2. RELAY
- 3. STARTER KEY
- 4. FUSE HOLDER
- 5. BATTERY
- 6. IGNITION
- 7. STARTER MOTOR
- 8. H.T. COIL